

Perspektive
Schloss:

T-BM-U2471 .../D 92/... M2

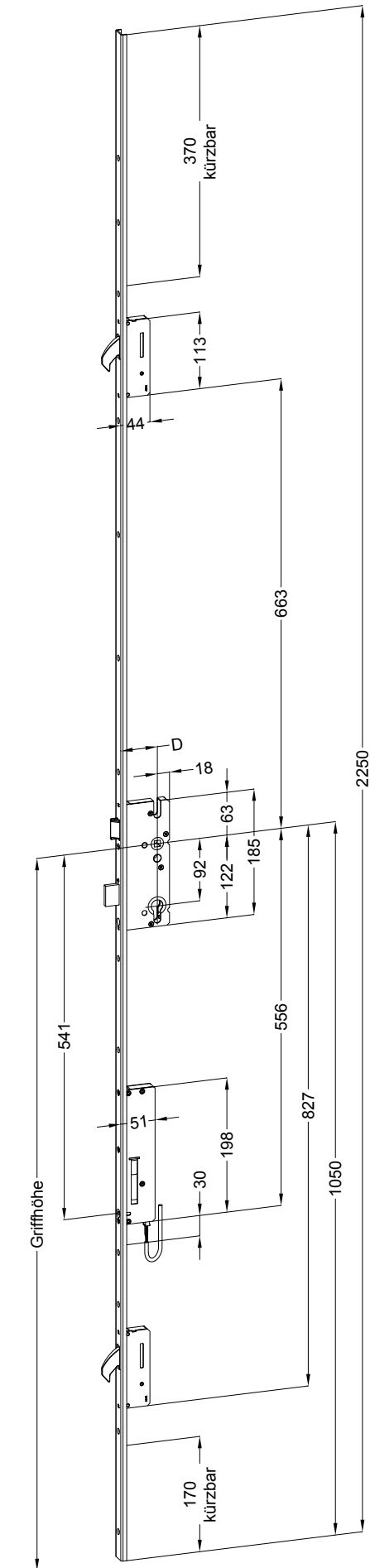

Technische Änderungen vorbehalten!

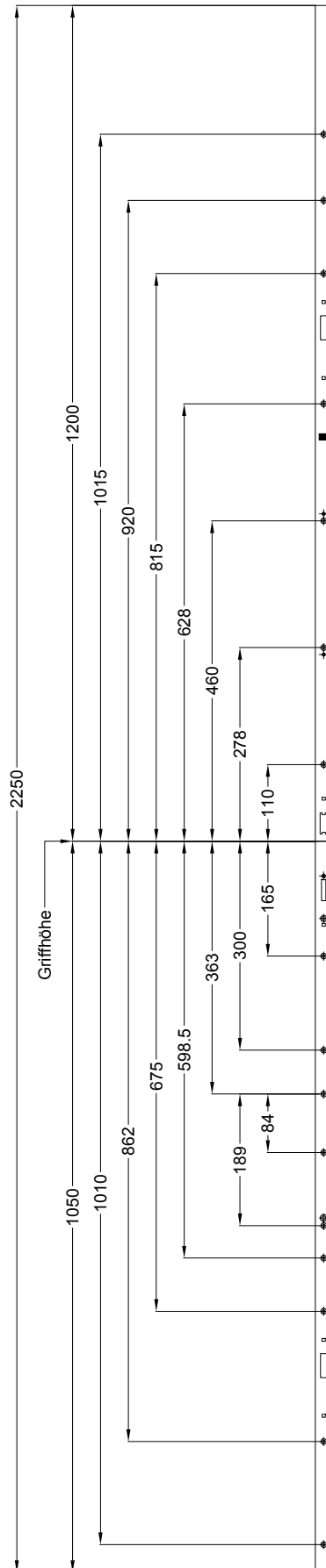
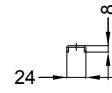

Ansichten
Schloss:

T-BM-U2471 .../D 92/... M2

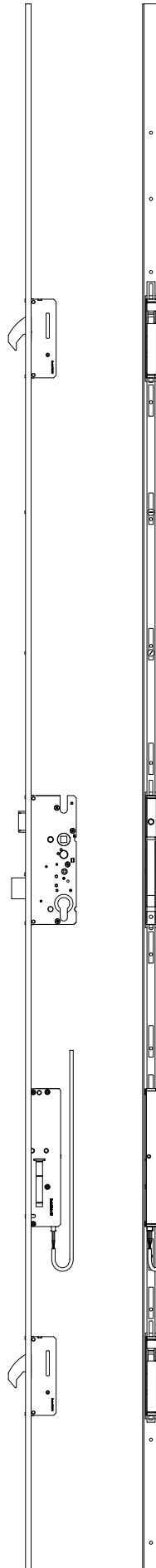

Technische Änderungen vorbehalten!

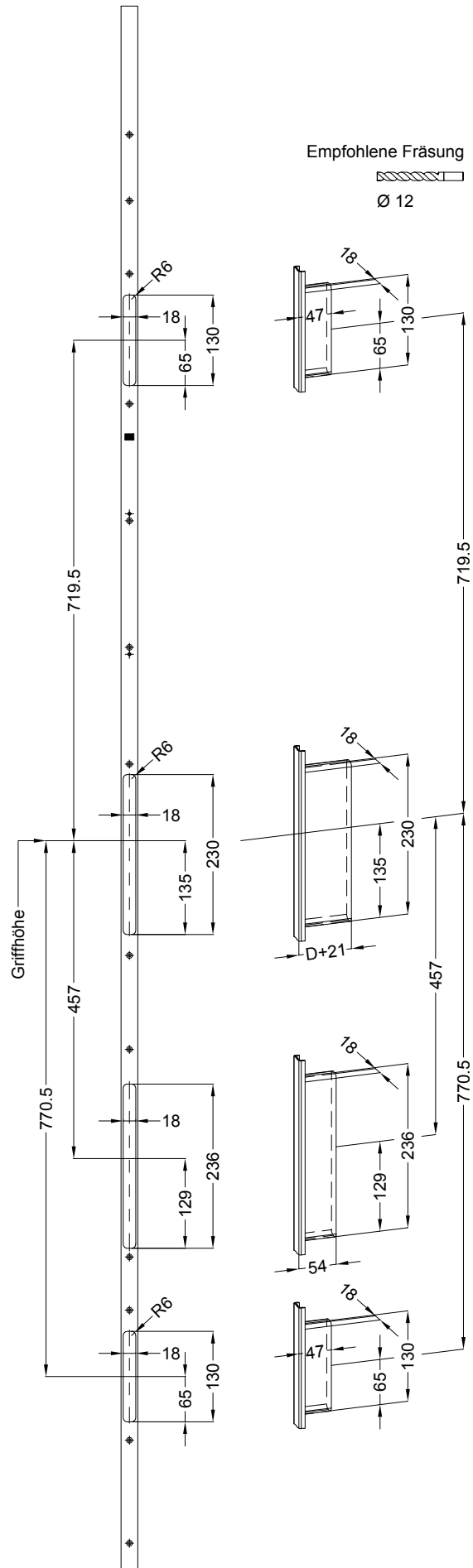

Allgemeine Vermaung

Frsmae

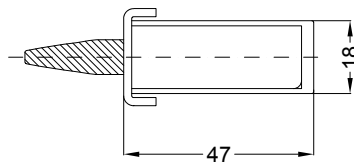
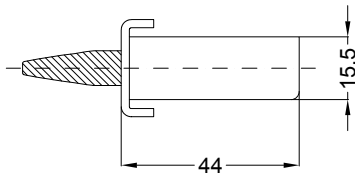

Situation
 Schwenkriegel
 TM6 EV

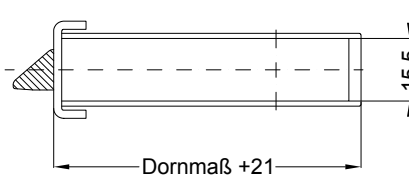
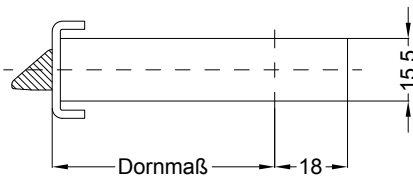

Situation
 Falle

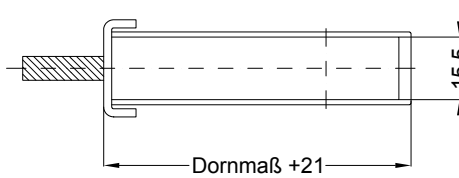
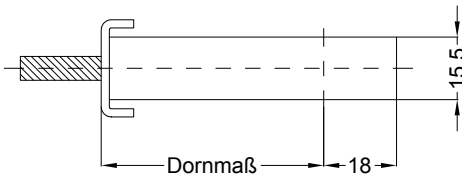

Situation
 Riegel

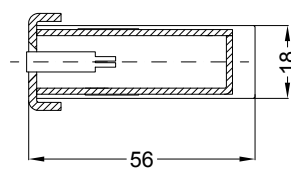
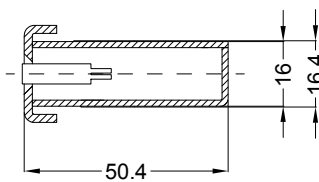

Situation
 Motorkasten
 blueMotion

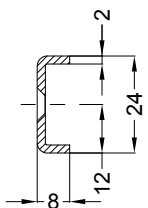

Lage
 Schloss

