

# FAB U26-BN13-60 MV2 Routing Details

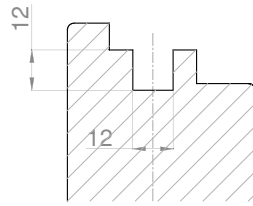

Section A-A

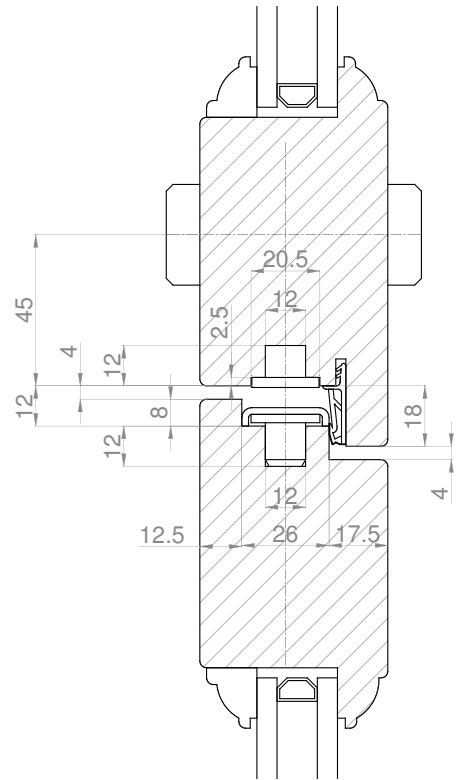
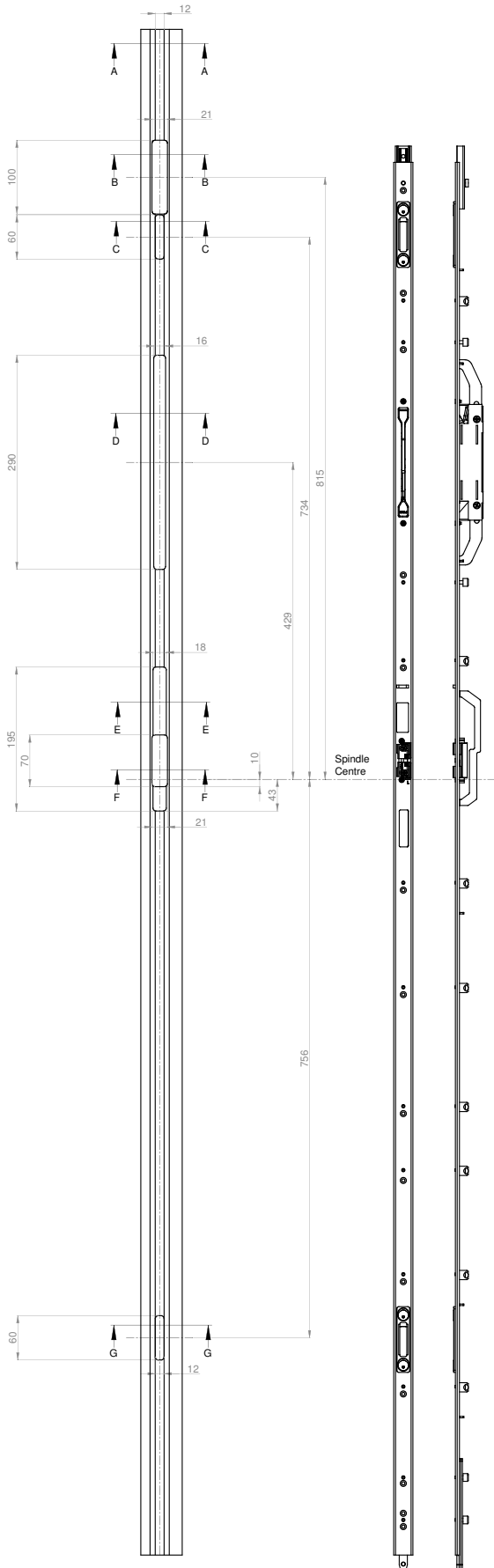
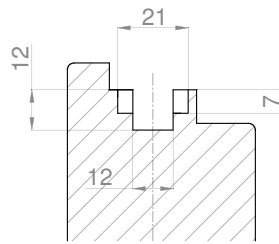

Section B-B

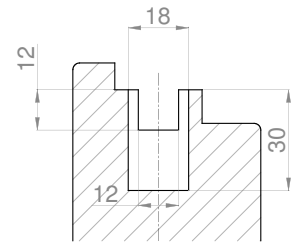

Section E-E

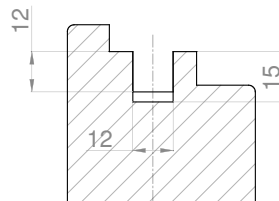

Section C-C

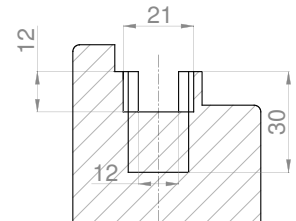

Section F-F

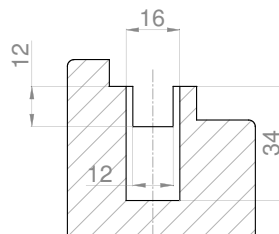

Section D-D

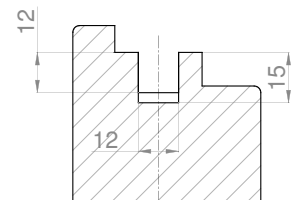

Section G-G