

Perspektive
Schloss:

STV-AP4 E/B/D1 F1669 .../D 92/... M2

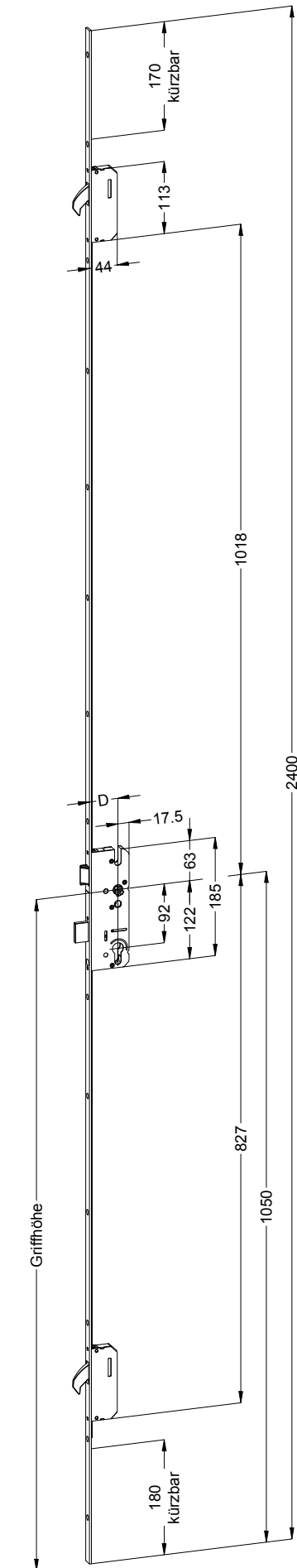

Technische Änderungen vorbehalten!

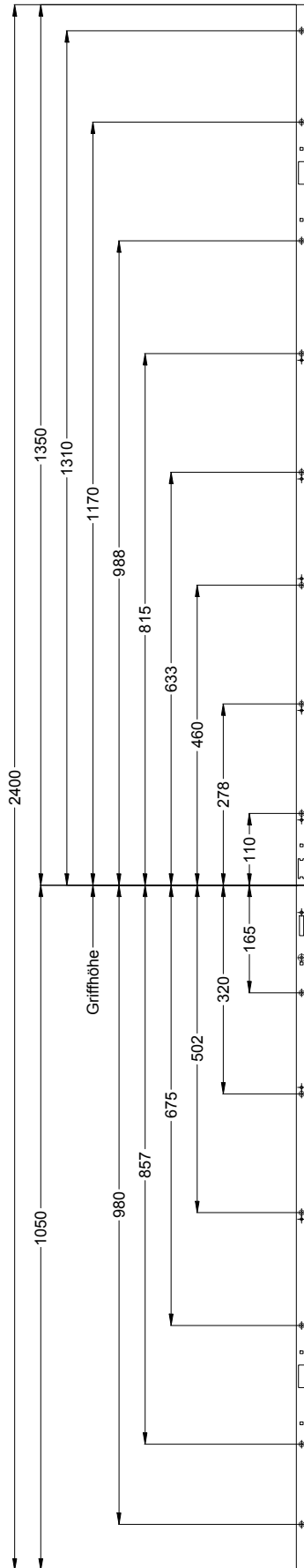
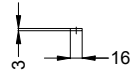

Ansichten
Schloss:

STV-AP4 E/B/D1 F1669 .../D 92/... M2

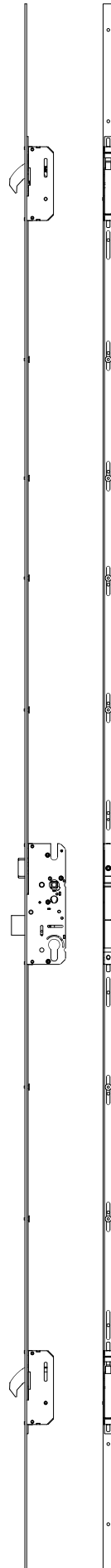

Technische Änderungen vorbehalten!

Allgemeine Vermaung

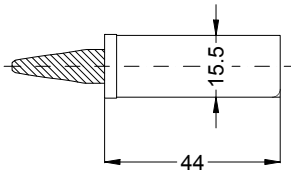

Frsmae

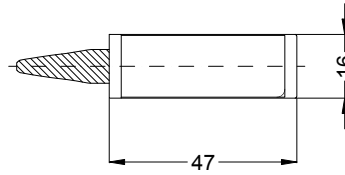

Situation
Schwenkriegel

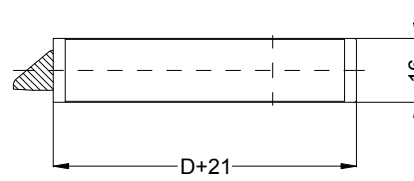
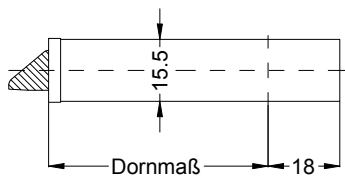

Situation
Falle

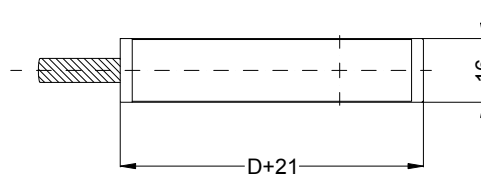
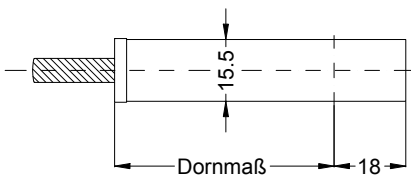

Situation
Riegel

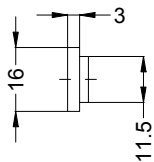

Lage
Schloss

