

activPilot

SKG - Sicherheit für Kunststoffenster

Concept / Select / Topstar

DuoPort SK

Comfort ERGO

Allgemeine Richtlinien zur Montageanleitung activPilot (SKG) für Kunststofffenster

Allgemeine Richtlinien zur Zusammenstellung und Montage von
Winkhaus activPilot Beschlägen für Fensterelemente
gemäß NEN 5096 Klasse 2.

Beschlagmontage

Die Beschlagmontage muss gemäß den Winkhaus Vorgaben erfolgen.

(Produktkataloge activPilot, Kapitel „Montageanleitung“).

Der Beschlag muss mit passenden Schrauben montiert werden .
Sicherheitsschließbleche müssen in einer Stahlarmierung mit
mindestens 1,5 mm oder einer Aluminiumarmierung mit min 2,0
mm Wandstärke verschraubt werden.

Griffolive

Der Beschlag muss mit einer SKG** zertifizierten Griffolive
ausgestattet werden.

Eine Griffolive mit Druckknopfbetätigung ist ausschließlich in
Kombination mit einbruchhemmender Verglasung die
mindestens der Klasse P4A nach EN 356 entspricht zulässig.

Kennzeichnung

Wenn alle Vorschriften eingehalten wurden, muss das SKG-
Kennzeichen an der Getriebeseite montiert werden.
Ein einfaches Entfernen (ohne Werkzeug) darf nicht möglich
sein.

Der Fensterhersteller bleibt zu jedem Zeitpunkt verantwortlich
für das von ihm gelieferte Endprodukt.

Bei Fragen wenden Sie sich bitte an den Zertifikatsinhaber,
Aug. Winkhaus GmbH & Co. KG.

Verriegelungsabstände

Die Abstände sind zum Erreichen der, vom Systemgeber
zugelassenen maximalen Verriegelungsabstände ggf. durch
Hinzufügen weiterer Verschlusspunkte zu optimieren !

Ergänzende Dokumente und Richtlinien

ergänzend zu den, in diesem Dokument beschriebenen
Vorgaben zur Herstellung von SKG Fenstern sind die folgende
Dokumente und Richtlinien zu berücksichtigen:

- Produktkatalog activPilot Comfort
- Produktkatalog duoPort
- allgemeine Produktinformationen activPilot
- Verarbeitungsrichtlinien des Systemgebers

Algemene richtlijnen voor de montage van activPilot (SKG) voor kunststof ramen

Algemene richtlijnen voor de samenstelling en montage van Winkhaus activPilot-beslag voor kunststof raamelementen volgens NEN 5096 klasse 2.

Beslagmontage

De beslagmontage dient volgens de Winkhaus opgave te geschieden.

(Productcatalogus activPilot, hoofdstuk "montagehandleiding").

Het beslag moet met passende schroeven gemonteerd worden . Veiligheidssluitplaten moeten in het staal, met een dikte van minstens 1,5 mm of aluminium van minimaal 2,0 mm wanddikte geschroefd worden.

Raamgreep of raamkruk

Het beslag dient met een door SKG** goedgekeurde raamgreep uitgevoerd worden.

Een raamgreep met drukknopbediening is alleen toegestaan in combinatie met inbraakwerend glas dat minstens aan de klasse P4A volgens EN 356 voldoet.

Merktken

Als alle voorschriften zijn aangehouden moet het SKG-merktken aan de sluitzijde van het raam met een niet eenvoudig verwijderbare bevestiging worden aangebracht. De ramenfabrikant blijft ten alle tijden verantwoordelijk voor het door hem geleverde eindproduct.

Voor vragen kunt u zich wenden tot de certificaathouder:
Aug. Winkhaus GmbH & Co.KG.

Vergrendelings- of sluitpuntafstanden

De afstanden kunnen gemaakt worden zoals door de systeemleverancier toegelaten maximale vergrendelingsafstanden of door meerdere sluitpunten aan te brengen!

Aanvullende documenten en richtlijnen

Aanvullend op de, in dit document beschreven aanwijzingen voor het fabriceren van SKG ramen, zijn de volgende documenten en richtlijnen in acht te nemen:

- Productcatalogus activPilot Concept
- Productcatalogus activPilot Comfort
- Productcatalogus duoPort
- Algemene productinformatie activPilot Concept
- Verwerkingsrichtlijnen van de systeemprouducent

Verschraubungen der Beschlagteile

Schraubentabelle

Bauteile	Detail	Maß	Vorborenen \varnothing
Fensterrahmen*1	für Bauwerke geeignete Befestigungsmittel		
Flügelteile (Getriebebeschienen, Mittenverriegelungen, Koppelemente Eckumlenkungen, Oberschienen, Aufläufe)	Beschlagschraube (Senkkopf)	3,9 x min. 25 mm	
Rahmenteile (SBS.K..., SBK.K..., SBA.K..., Auflauf,...)	Vorkammer	Beschlagschraube 4,0 x min. 35mm	
	Stahllarmierung	Bohrschraube: 3,9 x min. 28 mm oder Beschlagschraube 4,0 x min. 35mm	3,0 mm
Scherenlager	 Auswahl und Verarbeitung entsprechend technischer Richtlinie TBDK		
Ecklager			
Flügelager			
Griffolive	Maschinenschraube (Senkkopf)	M5 x 40	

*1 Schrauben werden in die Stahllarmierung (Mindestwandstärke 1,5 mm) verschraubt. Schraubtlängen zur Befestigung des Flügelbeschlags und der Schließteile können der Profilsituation angepasst werden.



Die Auswahl der einzusetzenden Befestigungsschrauben erfolgt entsprechend des Flügelgewichts unter Berücksichtigung der technischen Richtlinie TBDK.

De keuze van de toe te passen bevestigingsschroeven dient te worden bepaald aan de hand van het vleugelgewicht en conform de technische richtlijnen van TBDK.

<http://www.fvsb.de/ggsb/richtlinien.asp>

Montagepositionen der Aufläufe

Montagehinweise Aufläufe / Falzluftbegrenzer



Bild 3:
Position der Aufläufe bei 1-flügeligen Fenstern



Bild 3:
Position der Aufläufe bei 2-flügeligen Fenstern

Informativ Artikelvarianten Aufläufe

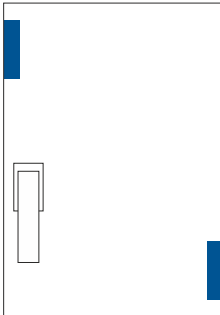
Abgestimmt auf die Montagesituation können folgende Aufläufe zum Einsatz kommen:

Auflauf AL.M

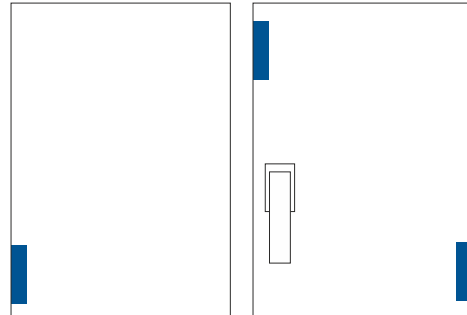
Zur Montage in der entsprechenden Lochgruppe der Mittsverriegelung
Befestigung mit 1x Beschlagschraube 4,0 x 20

Auflauf AL BN

Direkte Verschraubung in der Beschlagnut
Befestigung mit 1x Beschlagschraube 4,0 x 20

Flügelheber FH

Montage im Blendrahmen
Befestigung mit 2x Beschlagschraube 4,0 x 20

Auflauf K.SBS

Klemmung in Sicherheitsschließblech SBS.K.xxx

Auflauf AL D

Montage im Blendrahmen. Durch Formteil FT.WSK an unterschiedliche Profilsysteme anpassbar
Befestigung mit 2x Beschlagschraube 4,0 x 30

Alternative Aufläufe anderer Hersteller sind zulässig wenn:

- Die Falzluft auf max. 2,5 mm begrenzt wird
- Die Befestigung durch Verschrauben erfolgt



Bild 4:
Position des Auflaufes, Luft zwischen Auflauf und Flügelkante (Beispiel Winkhaus AL.D)



AL.M

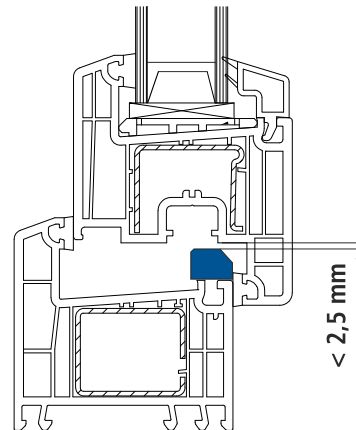
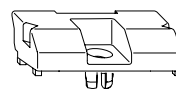
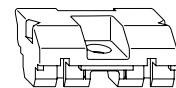

AL.BN

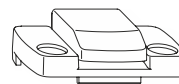

FH.152

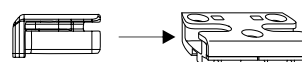

AL.K.SBS

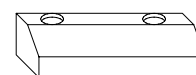

AL.D

Sicherung der Bedienelemente

Montage Stulpplatte SKG

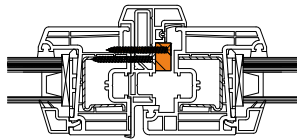

- Aluminiumblock
120 x 18 x 10
oder
Aluminiumwinkel
120 x 20 x 10 x 3mm

Befestigung mit
3 Schrauben
4,0 x 35 mm

oder

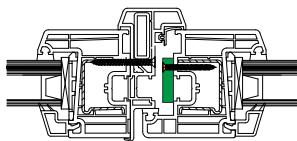

- Stulpniederhalter SNH.AGR
Montage erfolgt auf DK Seite
gegenüber dem Stulpbedienhebel
Befestigung mit
2 Schrauben
4,0 x 25 mm

Getriebe GASM + GASK



Getriebe GAM + GAK

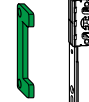

Beschlagübersichten

Erklärung zur Beschlagmatrix

Oberseite
Beschlagteile
Anwendungsbereiche

Concept **innenöffnend, mittiger Griff Sitz** ^{B-1}

211121 Drehkippenfenster

211721 Drehfenster mit AWRD

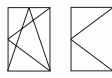

FFB	350 - 370	371 - 600	601 - 800	801 - 1025	1026 - 1250	1251 - 1475	1476 - 1725	V800
FFH	OS1.600	OS1.600	OS2.800	OS2.1025-1	OS2.1250-1	OS2.1475-1	OS2.1475-1 +ZS+FT	
325 - 510 GAM.800		B:H 4	B:H 4	B:H 5	B:H 5	B:H 5	B:H 6	
511 - 710 GAM.800				B:H 5	B:H 5	B:H 5	B:H 6	
711 - 980 GAM.1050-1					B:H 5	B:H 5	B:H 6	711 - 980 M.500-1
981 - 1300 GAM.1400-1							B:H 6	981 - 1300 M.500-1
1301 - 1400 GAM.1400-1							>2,5m ² 8	1301 - 1400 M.750-1
1401 - 1800 GAM.1800-2						>2,5m ² 8	>2,5m ² 9	1401 - 1800 MK.500-1 M.500-1
1801 - 2300 GAM.2300-3 (2x SBS)			> ,5m ² 8	>2,5m ² 9	>2,5m ² 9	>2,5m ² 9	>2,5m ² 10	1801 - 2300 MK.500-1 MK.500-1 M.500-1
für Verriegelungsabstände 700 mm Anhang berücksichtigen !								
	350 - 370 M.250-1	371 - 600 M.250-1	601 - 800 M.500-1	801 - 1025 M.500-1	1026 - 1250 M.750-1	1251 - 1475 MK.500-1 M.500-1	1475 - 1725 MK.500-1 M.750-1	

Getriebeseite
Beschlagteile
Anwendungsbereiche

Bandseite
Beschlagteile
Anwendungsbereiche

Anzahl der
Sicherheits-
verriegelungen

Unterseite
Beschlagteile
Anwendungsbereiche

Kennzeichnung Produkthaftung



Einhaltung der Produkthaftung prüfen !
(B:H > 2:1 , Fläche >2,5m²)

Größe liegt außerhalb der Produkthaftung
(B:H > 2:1 , Fläche >2,5m²)

Für Details ist die Hinweise zur
Produkthaftung aus den Produktkatalogen
unbedingt hinzuzuziehen !

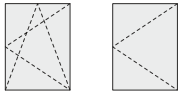

activPilot Concept Dreh- /Drehkippfenster innenöffnend

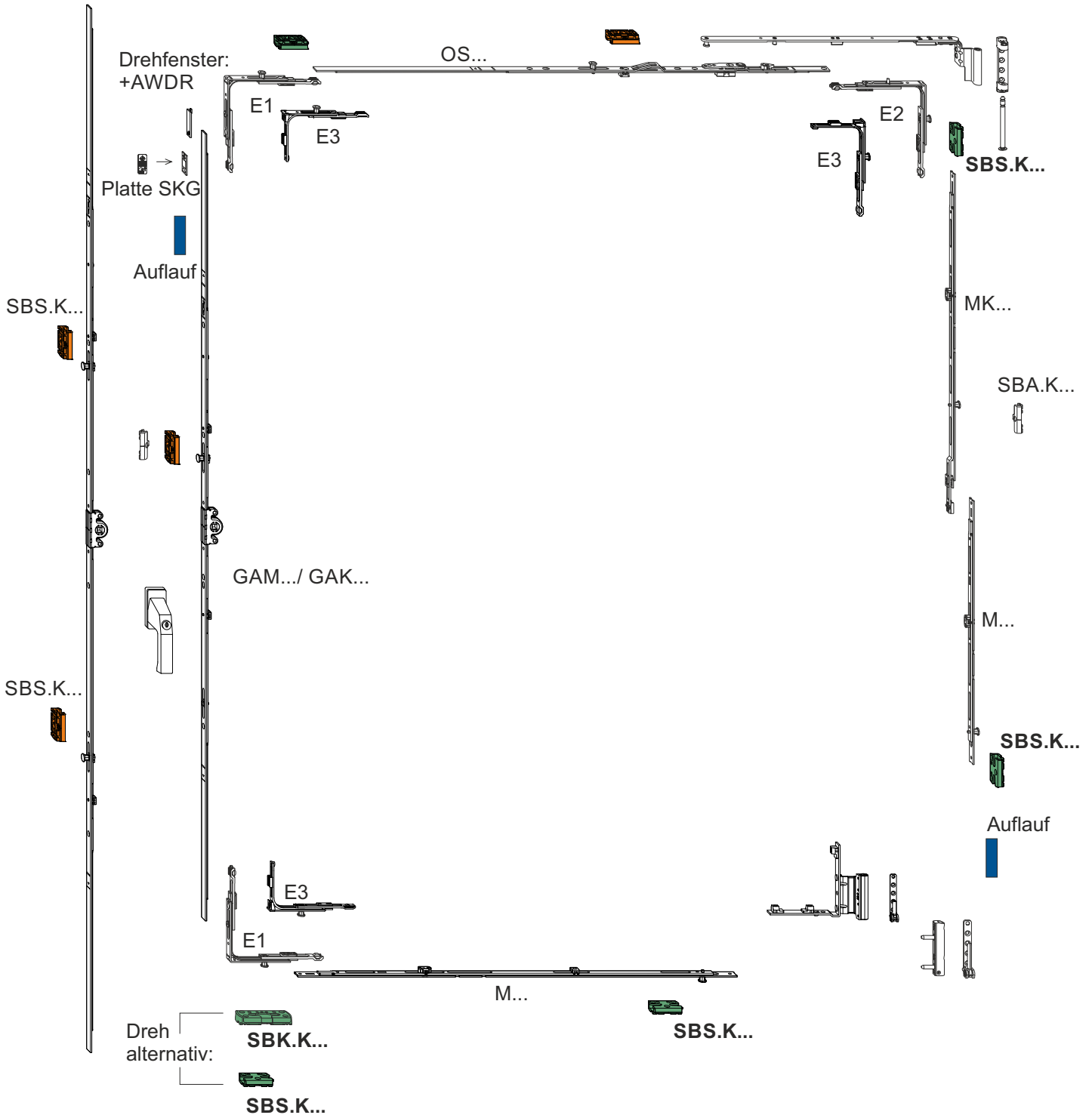

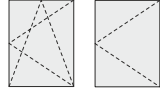

activPilot Concept
Drehkippenfenster
Drehfenster mit AWDR
innenöffnend, mittlerer Griffsitz

211121
211721

FFB / FFH	350 - 370 OS1.600	371 - 600 OS1.600	601 - 800 OS2.800	801 - 1025 OS2.1025-1	1026 - 1250 OS2.1250-1	1251 - 1475 OS2.1475-1	1476 - 1725 OS2.1475-1 +ZS+FT	V800*
325 - 510 GAM.800	X		B:H 4	B:H 4	B:H 5	B:H 5	B:H 5	B:H 6
511 - 710 GAM.800	4	4	4	B:H 5	B:H 5	B:H 5	B:H 6	
711 - 980 GAM.1050-1	4	4	4	5	B:H 5	B:H 5	B:H 6	861 - 980 M.500-1
981 - 1300 GAM.1400-1	4	4	4	5	5	5	B:H 6	981 - 1285 M.500-1
1301 - 1400 GAM.1400-1	6 [†]	6 [†]	6 [†]	7 [†]	7 [†]	7 [†]	>2,5m ² 8 [†]	1286 - 1535 M.750-1
1401 - 1800 GAM.1800-2	7 [†]	7 [†]	7 [†]	8 [†]	8 [†]	>2,5m ² 8 [†]	>2,5m ² 9 [†]	1536 - 1785 MK.500-1 M.500-1
1801 - 2300 GAM.2300-3 (2x SBS)	8 [†]	8 [†]	>,5m ² 8 [†]	>2,5m ² 9 [†]	>2,5m ² 9 [†]	>2,5m ² 9 [†]	>2,5m ² 10 [†]	1786 - 2035 MK.750-1 M.500-1 2036 - 2300 MK.750-1 M.750-1
			*für Verriegelungsabstände 700 mm Anhang berücksichtigen !					
	350 - 430 M.250-1	431 - 630 M.250-1	631 - 800 M.500-1	801 - 1025 M.500-1	1026 - 1250 M.750-1	1251 - 1475 MK.500-1 M.500-1	1475 - 1725 MK.500-1 M.750-1	

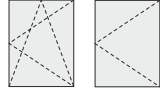

activPilot Concept
Drehkipfenster
Drehfenster mit AWDR

211111
211711

innenöffnend, konstanter Griffsitz

FFB / FFH	350 - 370	371 - 600	601 - 800	801 - 1025	1026 - 1250	1251 - 1475	1476 - 1725	V800*
	OS1.600	OS1.600	OS2.800	OS2.1025-1	OS2.1250-1	OS2.1475-1	OS2.1475-1 +ZS+FT	
230 - 325 GAK.465								
326 - 420 GAK.465								
421 - 460 GAK.465								
461 - 700 GAK.710								
701 - 850 GAK.945-1								
851 - 1100 GAK.1100-1								861 - 980 M.500-1
1100 - 1325 GAK.1325-1								981 - 1285 M.500-1
1326 - 1550 GAK.1550-1								1286 - 1535 M.750-1
1551 - 1775 GAK.1775-2								1536 - 1785 MK.500-1 M.500-1
1776 - 2000 GAK.2000-2								1786 - 2035 MK.750-1 M.500-1
2001 - 2225 GAK.2225-2								2036 - 2300 MK.750-1 M.750-1
	350 - 370 M.250-1 	371 - 630 M.250-1 	631 - 800 M.500-1	801 - 1025 M.500-1	1026 - 1250 M.750-1	1251 - 1475 MK.500-1 M.500-1	1475 - 1725 MK.500-1 M.750-1	

Rahmenteilpositionen Maßbezüge DK Fenster

Mittiger Griffsitz GAM...

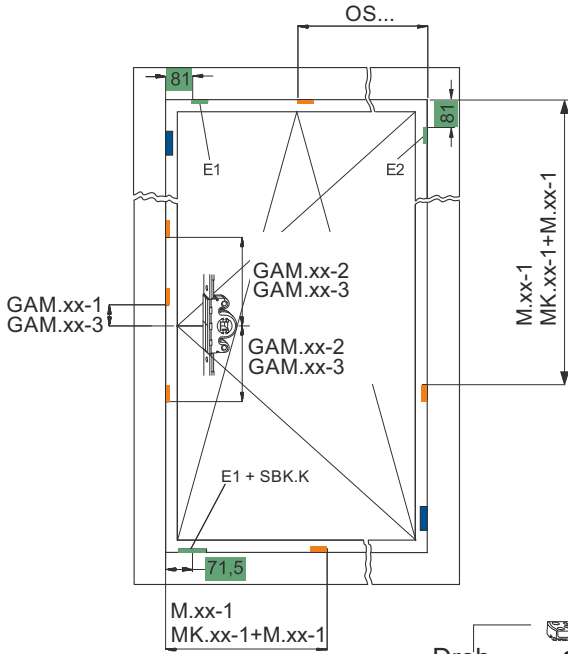

Konstanter Griffsitz GAK...

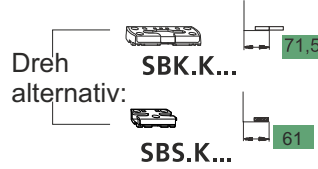
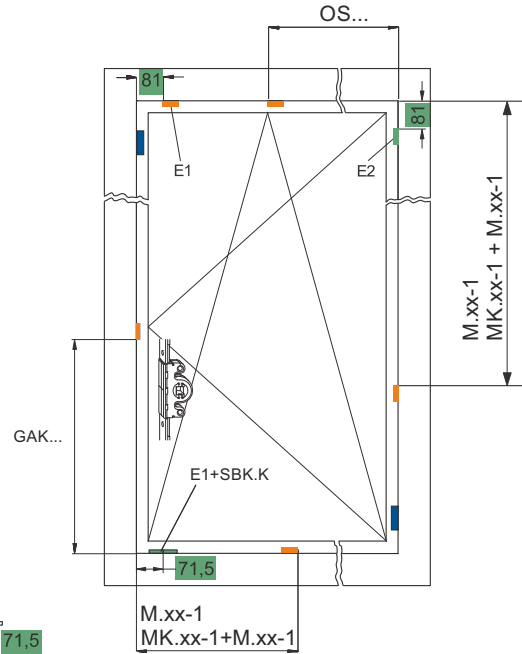

Maßbezug Sicherheitsschließteil SBS.K

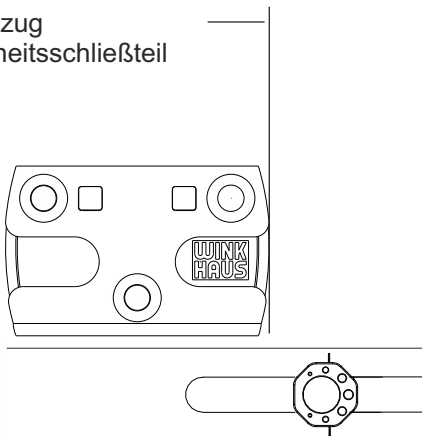

Maßbezug Sicherheitskippschließblech SBS.K

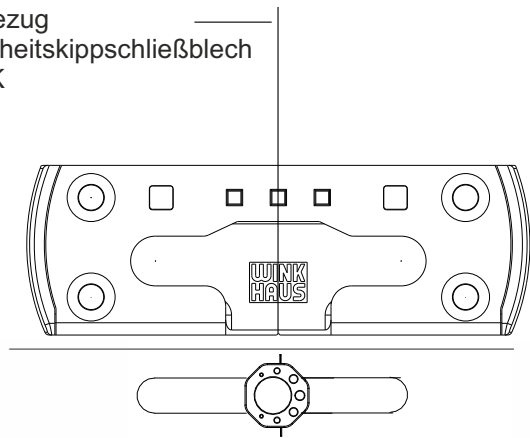

Rahmenteilpositionen Getriebe

Verriegelungsabstand 800 mm

konstanter Griffsitz 1 flg

FFH min/max	Getriebe		SB Positionen
230 - 460	GA..K.465		--
461 - 700	GA..K.710		--
701 - 850	GA..K.945-1		385
851 - 1100	GA..K.1100-1		500
1101 - 1325	GA..K.1325-1		750
1326 - 1550	GA..K.1550-1	1	750
1550 - 1775	GA..K.1775-2	2	750 1250
1776 - 2000	GA..K.2000-2	2	750 1250
2001 - 2225	GA..K.2225-2	2	750 1500



mittiger Griffsitz 1 flg

FFH min/max	Getriebe		SB Positionen
326 - 800	GA..M 800		--
800 - 1050	GA..M.1050-1		127
1051 - 1300	GA..M.1400-1		127
1301 - 1400	GA..M.1400-1	1	127
1401 - 1800	GA..M.1800-2	2	-340 260
1801 - 2300	GA..M.2300-3	2	-520 127 692



Verriegelungsabstand 700 mm

konstanter Griffsitz

FFH min/max	Getriebe		SB Positionen
230 - 460	GA..K.465		--
461 - 700	GA..K.710		--
701 - 850	GA..K.945-1		385
851 - 1100	GA..K.1100-1		500
1101 - 1325	GA..K.1325-2		385 750
1326 - 1550	GA..K.1550-2	1	385 1000
1551 - 1775	GA..K.1775-3	2	385 750 1250
1776 - 2000	GA..K.2000-4	2	385 750 1250 1500
2001 - 2225	GA..K.2225-4	2	385 750 1250 1750



mittiger Griffsitz

FFH min/max	Getriebe		SB Positionen
325 - 800	GA..M 800		--
800 - 1050	GA..M.1050-1		127
1051 - 1300	GA..M.1400-2		-223 127
1301 - 1400	GA..M.1400-2	1	-223 127
1401 - 1800	GA..M.1800-2	2	-340 260
1801 - 2300	GA..M..2300-3	2	-520 127 692



Rahmenteilpositionen

Mittenverriegelungen unten

Oberschiene

Bandseite

Verriegelungsabstand 800 mm



konstanter + mittiger Griffsitz

FFH min/max	M../MK..		SB Positionen.	
861 - 1285	M.500-1		500	
1286 - 1535	M.750-1	1	750	
1536 - 1785	MK.500-1 + M.500-1	1	500	1000
1786 - 2035	MK.750-1 + M.500-1	1	750	1250
2036 - 2285	MK.750-1 + MK.750-1	2	750	1500

Bandseite

Verriegelungsabstand 700 mm

konstanter + mittiger Griffsitz

FFH min/max	M../MK..		SB Positionen		
760 - 1185	M.500-1		500		
1186 - 1435	M.750-1	1	750		
1436 - 1685	MK.500-1 + M.500-1	1	500	1000	
1686 - 1935	MK.750-1 + M.500-1	1	750	1250	
1936 - 2185	MK.500-1 + MK.500-1 + M.500-1	1	500	1000	1500
2185 - 2300	MK.750-1 + MK.500-1 + M.500-1	2	750	1000	1500

unten

Verriegelungsabstand 700 + 800 mm



FFB min/max	M../MK..		SB Positionen.		
270 - 630	M.250-1	1	230		
631 - 1025	M.500-1	1	480		
1026 - 1250	M.750-1	1	730		
1251 - 1475	MK.500-1 + M.500-1	1	480	980	
1476 - 1725	MK.750-1 + M.500-1	1	730	1230	

Oberschiene

Verriegelungsabstand 700 mm



FFB min/max	M../MK..		SB Positionen.		
270 - 600	OS1.600		-		
601 - 800	OS2.800		-		
776 - 1025	OS2.1025-1	1	480		
1026 - 1275	OS2.1025-1 + MK.250-1	1	480		
1276 - 1475	OS2.1025-1 + MK.500-1	1	480		
1476 - 1525	OS2.1025-1 + MK.250-1+ZSR	2	480	250 (von Griffseite)	
1526 - 1725	OS2.1025-1 + MK.500-1+ZSR	2	480	500 (von Griffseite)	

Oberschiene

Verriegelungsabstand 800 mm

FFB min/max	M../MK..		SB Positionen.		
270 - 600	OS1.600	-	-		
601 - 800	OS2.800	-	-		
801 - 1025	OS2.1025-1	1	480		
1026 - 1250	OS2.1250-1	1	480		
1251 - 1725	OS2.1475-1 (+ZSR)	1	730		



activPilot Concept Stulpfenster

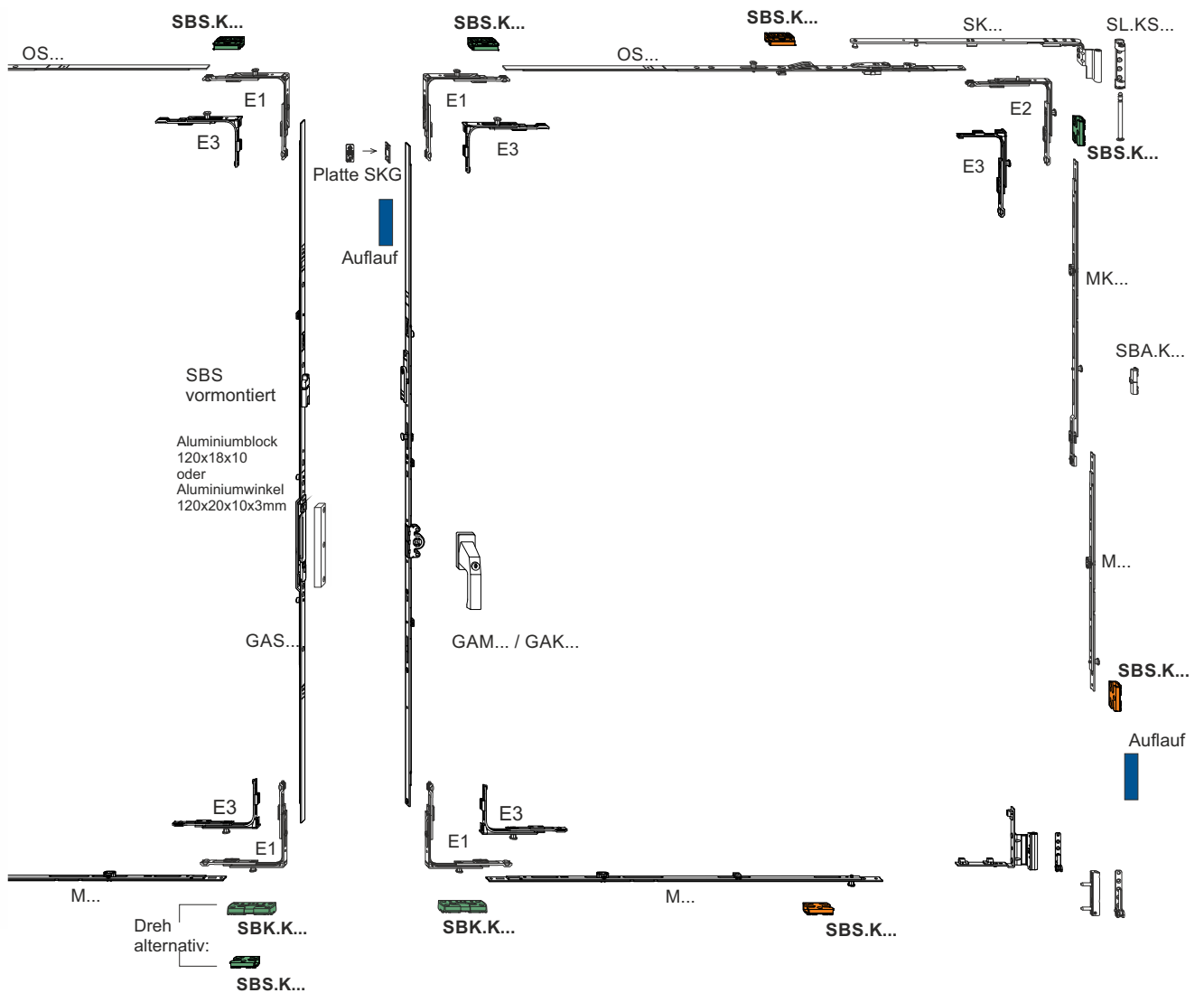



activPilot Concept
Stulpfenster, erstöffnender Flügel
Drehkipp
innenöffnend, mittiger Griffsitz



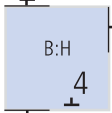
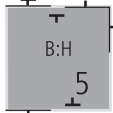
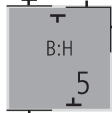
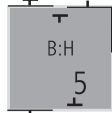
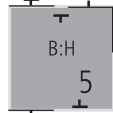
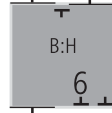
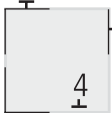
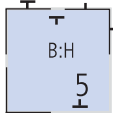
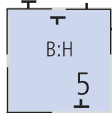
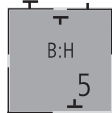
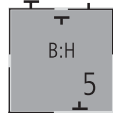
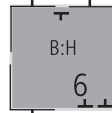
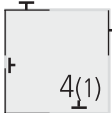
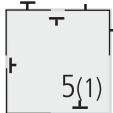
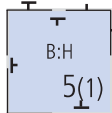
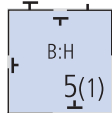
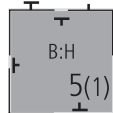
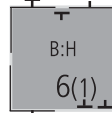
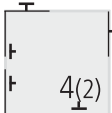
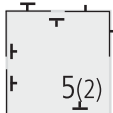
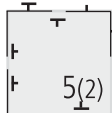
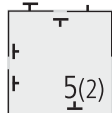
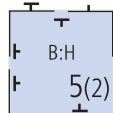
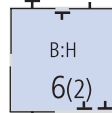
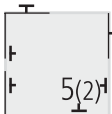
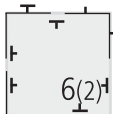
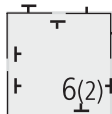
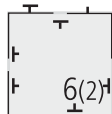
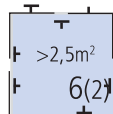
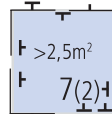
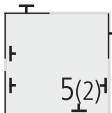
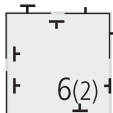
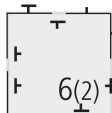
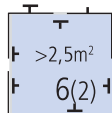
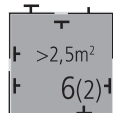
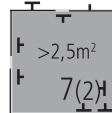
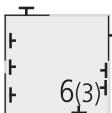
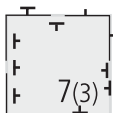
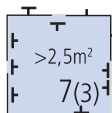
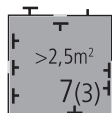
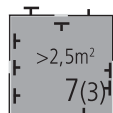
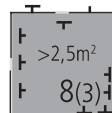
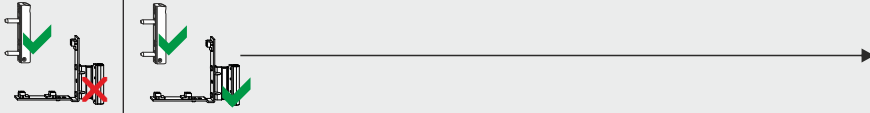

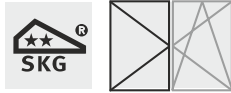



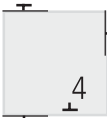
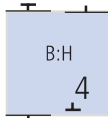
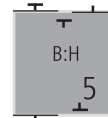
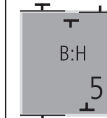
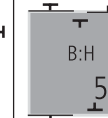
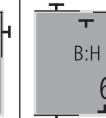
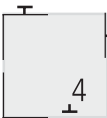
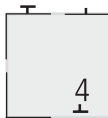
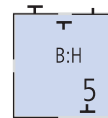
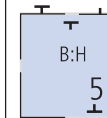
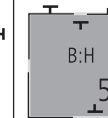
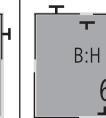
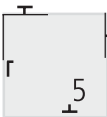
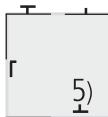
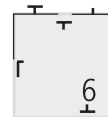
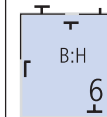
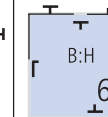
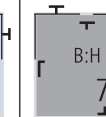

211221

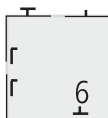
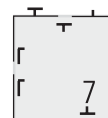
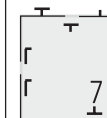
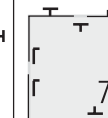
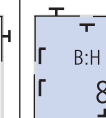
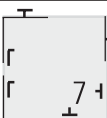
FFB \ FFH	370 - 600 OS1.600	601 - 800 OS2.800	801 - 1025 OS2.1025-1	1026 - 1250 OS2.1250-1	1251 - 1475 OS2.1475-1	1476 - 1725 OS2.1475-1 +ZS+FT		V800* 
410 - 560 GAM.800								
561 - 710 GAM.800								
711 - 980 GAM.1050-1							861 - 980 M.500-1	
981 - 1300 GAM.1400-2							981 - 1285 M.500-1	
1301 - 1400 GAM.1400-2							1286 - 1535 M.750-1	
1401 - 1800 GAM.1800-2							1536 - 1785 MK.500-1 M.500-1	
1801 - 2300 GAM.2300-3							1786 - 2035 MK.750-1 M.500-1 2036 - 2300 MK.750-1 M.750-1	
* Verriegelungsabstand 700 mm siehe Rahmenteilpositionen !								
	350 - 430 M.250-1	431 - 630 M.250-1	631 - 800 M.500-1	801 - 1025 M.500-1	1026 - 1250 M.750-1	1251 - 1475 MK.500-1 M.500-1	1475 - 1725 MK.500-1 M.750-1	
								

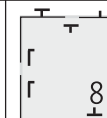
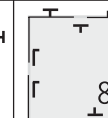
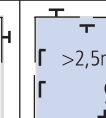
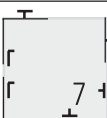
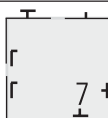

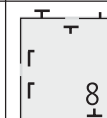
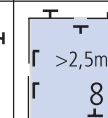
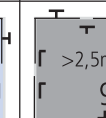
activPilot Concept
Stulpfenster, zweitöffnender Flügel
Dreh
innenöffnend, mittiger Griffsitz

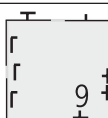
211221

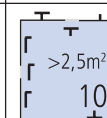
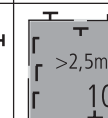
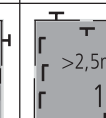
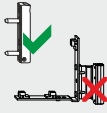
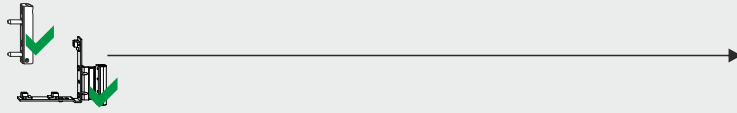
FFB \ FFH	370 - 600 OS1.600	601 - 800 OS2.800	801 - 1025 OS2.1025-1	1026 - 1250 OS2.1250-1	1251 - 1475 OS2.1475-1	1476 - 1725 OS2.1475-1 +ZS+FT		V800* 	
410 - 560 GASM.800									
561 - 710 GASM.800									
711 - 980 GASM.1050-1								861 - 980 M.500-1	
981 - 1300 GASM.1400-2								981 - 1285 M.500-1	
1301 - 1400 GASM.1400-2								1286 - 1535 M.750-1	
1401 - 1800 GASM.1800-2								1536 - 1785 MK.500-1 M.500-1	
1801 - 2300 GASM.2300-3								1786 - 2035 MK.750-1 M.500-1 2036 - 2300 MK.750-1 M.750-1	
			*Verriegelungsabstand 700 mm siehe Rahmenteilpositionen						
	350 - 430 M.250-1	431 - 630 M.250-1	631 - 800 M.500-1	801 - 1025 M.500-1	1026 - 1250 M.750-1	1251 - 1475 MK.500-1 M.500-1	1475 - 1725 MK.500-1 M.750-1		
									



activPilot Concept
Stulpfenster, erstöffnender Flügel
Drehkipp
innenöffnend, konstanter Griffsitz





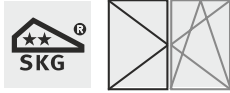

211211

FFB / FFH	370 - 600 OS1.600	601 - 800 OS2.800	801 - 1025 OS2.1025-1	1026 - 1250 OS2.1250-1	1251 - 1475 OS2.1475-1	1476 - 1725 OS2.1475-1 +ZS+FT	V800*
450 - 460 GAK.465							
461 700 GAK.710							
701 - 850 GAK.945-1							
851 - 1100 GAK.1100-1							861 - 980 M.500-1
1101 - 1325 GAK.1325-2							981 - 1285 M.500-1
1326 - 1550 GAK.1550-2							1286 - 1535 M.750-1
1551 - 1775 GAK.1775-2							1536 - 1785 MK.500-1 M.500-1
1776 - 2000 GAK.2000-2							1786 - 2035 MK.750-1 M.500-1
2001 - 2225 GAK.2225-2							2036 - 2300 MK.750-1 M.750-1
	* Verriegelungsabstand 700 mm siehe Rahmenteilpositionen						
	350 - 430 M.250-1	431 - 630 M.250-1	631 - 800 M.500-1	801 - 1025 M.500-1	1026 - 1250 M.750-1	1251 - 1475 MK.500-1 M.500-1	1475 - 1725 MK.500-1 M.750-1

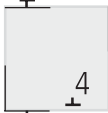
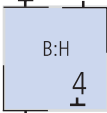
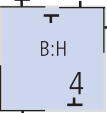
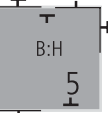
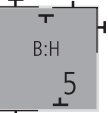
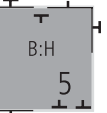
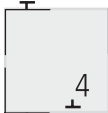
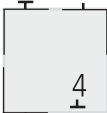
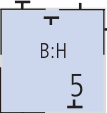
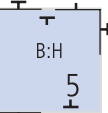
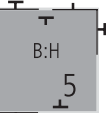
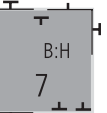
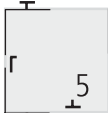
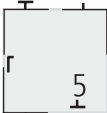
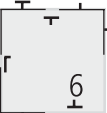
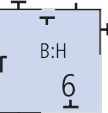
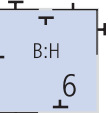
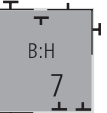
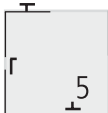
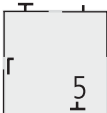
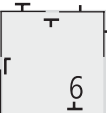
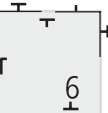
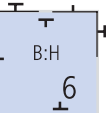
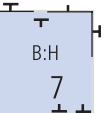
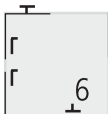
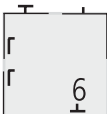
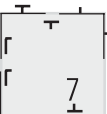
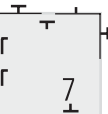
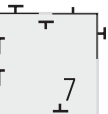
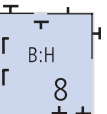
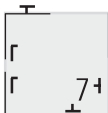
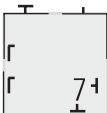
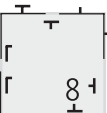
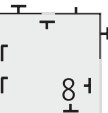
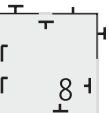
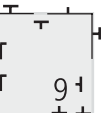

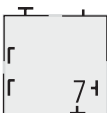
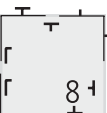
activPilot Concept
Stulpfenster, zweiföffnender Flügel
Dreh
innenöffnend, konstanter Griffsitz

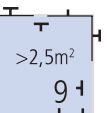
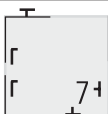
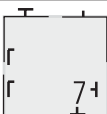
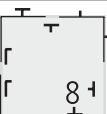
211211

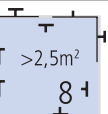
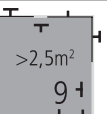
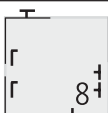
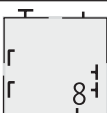
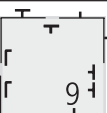
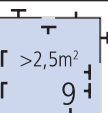
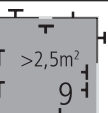
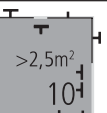
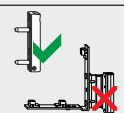
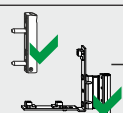
FFB / FFH	370 - 600	601 - 800	801 - 1025	1026 - 1250	1251 - 1475	1476 - 1725		V800*	
	OS1.600	OS2.800	OS2.1025-1	OS2.1250-1	OS2.1475-1	OS2.1475-1 +ZS+FT			
450 - 460 GASK.710									
461 - 700 GASK.710									
701 - 850 GASK.945-1									
851 - 1100 GASK.1100-1							861 - 980 M.500-1		
1101 - 1325 GASK.1325-2							981 - 1285 M.500-1		
1326 - 1550 GASK.1550-2							1286 - 1535 M.750-1		
1551 - 1775 GASK.1775-2							1536 - 1785 MK.500-1 M.500-1		
1776 - 2000 GASK.2000-2							1786 - 2035 MK.750-1 M.500-1		
2001 - 2225 GASK.2225-2							2036 - 2300 MK.750-1 M.750-1		
			* Verriegelungsabstand 700 mm siehe Rahmenteilpositionen!						
	350 - 430 M.250-1	431 - 630 M.250-1	631 - 800 M.500-1	801 - 1025 M.500-1	1026 - 1250 M.750-1	1251 - 1475 MK.500-1 M.500-1	1475 - 1725 MK.500-1 M.750-1		
			→						

Rahmenteilpositionen Maßbezüge Stulpfenster

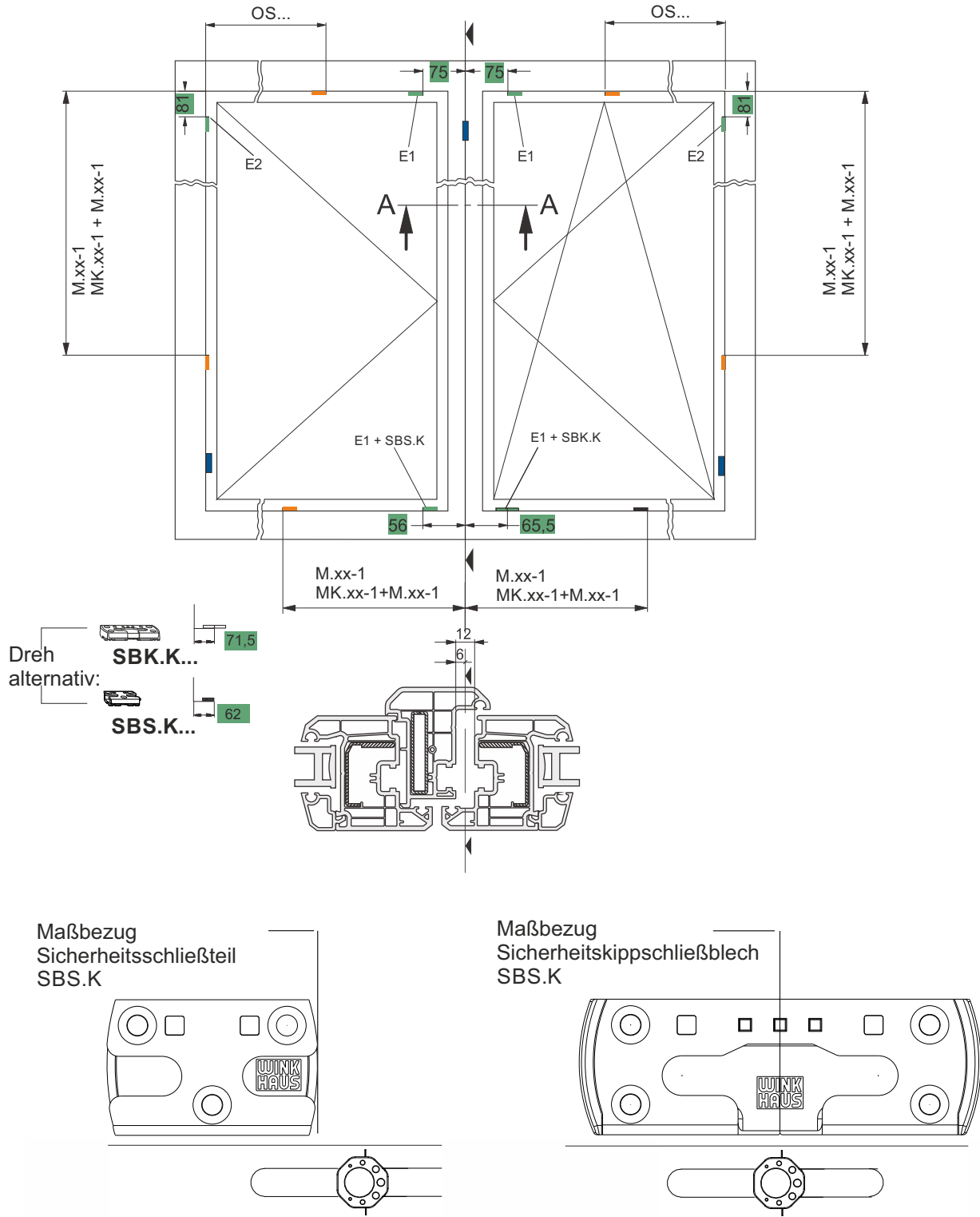

Rahmenteilpositionen

Mittenverriegelungen seitlich / unten

Oberschiene

Bandseite

Verriegelungsabstand 800 mm

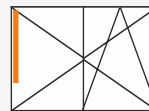

konstanter + mittiger Griffsitz

FFH min/max	M../MK..		SB Positionen.	
861 - 1285	M.500-1		500	
1286 - 1535	M.750-1	1	750	
1536 - 1785	MK.500-1 + M.500-1	1	500	1000
1786 - 2035	MK.750-1 + M.500-1	1	750	1250
2036 - 2285	MK.750-1 + MK.750-1	2	750	1500

Bandseite

Verriegelungsabstand 700 mm

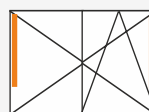

konstanter + mittiger Griffsitz

FFH min/max	M../MK..		SB Positionen	
760 - 1185	M.500-1		500	
1186 - 1435	M.750-1	1	750	
1436 - 1685	MK.500-1 + M.500-1	1	500	1000
1686 - 1935	MK.750-1 + M.500-1	1	750	1250
1936 - 2185	MK.500-1 + MK.500-1 + M.500-1	1	500	1000 1500
2185 - 2300	MK.750-1 + MK.500-1 + M.500-1	2	750	1000 1500

unten

Verriegelungsabstand 700 + 800 mm

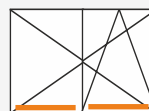



konstanter + mittiger Griffsitz

FFB min/max	M../MK..		SB Positionen.	
270 - 630	M.250-1	1	230	
631 - 1025	M.500-1	1	480	
1026 - 1250	M.750-1	1	730	
1251 - 1475	MK.500-1 + M.500-1	1	480	980
1476 - 1725	MK.750-1 + M.500-1	1	730	1230

Oberschiene

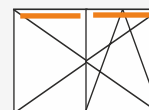
Verriegelungsabstand 700 + 800 mm



FFB min/max	M../MK..		SB Positionen.	
270 - 600	OS1.600	-	-	
601 - 800	OS2.800	-	-	
801 - 1025	OS2.1025-1	1	480	
1026 - 1250	OS2.1250-1	1	480	
1251 - 1725	OS2.1475-1 (+ZSR)	1	730	

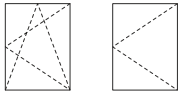

activPilot Concept Drehfenster mit Bändern innen- und außen öffnend

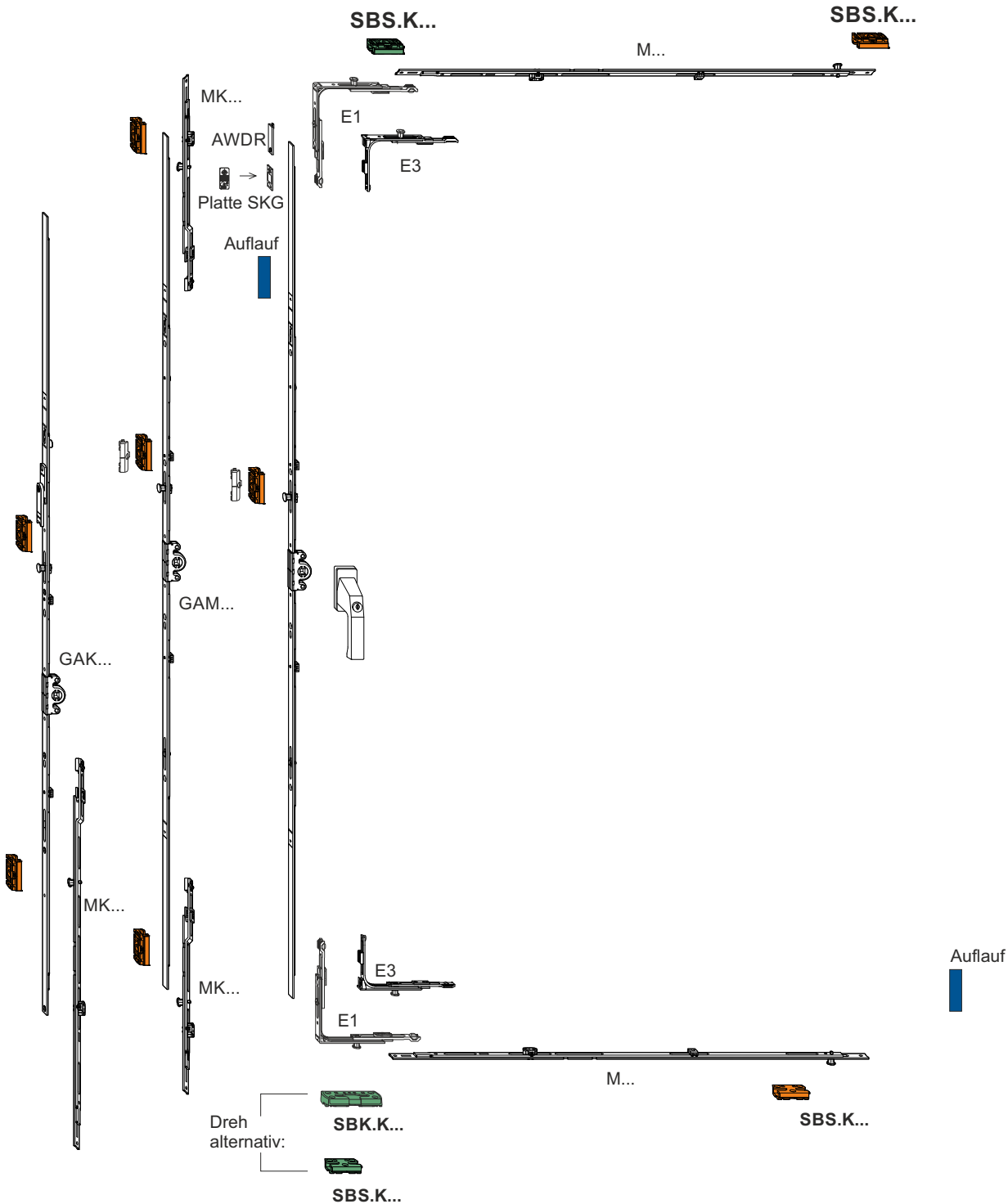

SKG geprüfte Bänder



activPilot Concept
Drehfenster
mit SKG geprüften Bändern
innenöffnend, konstanter Griffsitz





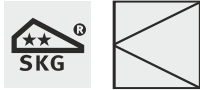





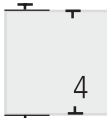
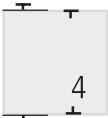
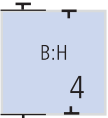
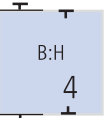
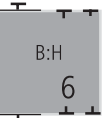

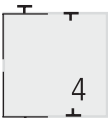
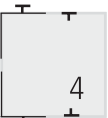
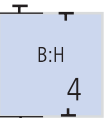

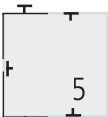
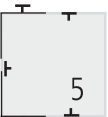

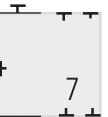

211411

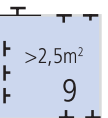
FFB / FFH	350 - 630 M.250-1	631 - 1025 M.500-1	1026 - 1250 M.750-1	1251 - 1475 MK.500-1 M.500-1	1476 - 1725 MK.500-1 M.750-1			V800* 	
230 - 325 GAK.465	B:H 4	B:H 4	B:H 4	B:H 4	B:H 6				
326 - 420 GAK.465	B:H 4	B:H 4	B:H 4	B:H 4	B:H 6				
421 - 460 GAK.465	B:H 4	B:H 4	B:H 4	B:H 4	B:H 6				
461 - 700 GAK.710	B:H 4	B:H 4	B:H 4	B:H 4	B:H 6			SKG geprüfte Bänder	
701 - 850 GAK.945-1	B:H 4	B:H 4	B:H 4	B:H 4	B:H 6				
851 - 1100 GAK.1100-1	B:H 4	B:H 4	B:H 4	B:H 4	B:H 6				
1101 - 1325 GAK.1325-1	B:H 4	B:H 4	B:H 4	B:H 4	B:H 6				
1326 - 1550 GAK.1550-1	B:H 5	B:H 5	B:H 5	B:H 5	B:H 7				
1551 - 1775 GAK.1775-2	B:H 6	B:H 6	B:H 6	B:H 6	B:H >2,5m ² 8				
1776 - 2000 GAK.2000-2	B:H 6	B:H 6	B:H 6	B:H >2,5m ² 6	B:H >2,5m ² 8				
2001 - 2225 GAK.2225-2	B:H 6	B:H 6	B:H >2,5m ² 6	B:H >2,5m ² 6	B:H >2,5m ² 8	* Verriegelungsabstand 700 mm siehe Rahmenteilpositionen !			
	350 - 630 M.250-1	631 - 1025 M.500-1	1026 - 1250 M.750-1	1251 - 1475 MK.500-1 M.500-1	1475 - 1725 MK.500-1 M.750-1				

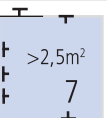
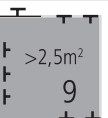

activPilot Concept
Drehfenster
mit SKG geprüften Bändern
außenöffnend, mittiger Griffsitz

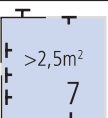
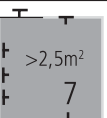
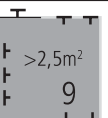



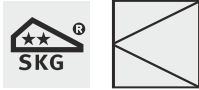





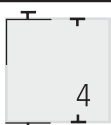
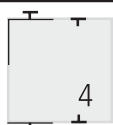
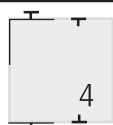

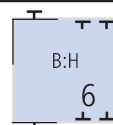
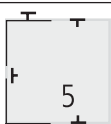
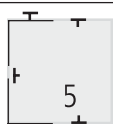
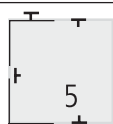

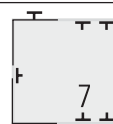
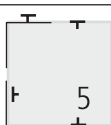
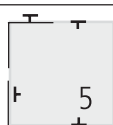



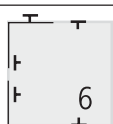
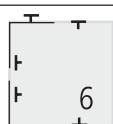

211422

FFB / FFH	350 - 630	631 - 1025	1026 - 1250	1251 - 1475	1476 - 1725			V800* 
	M.250-1	M.500-1	M.750-1	MK.500-1 M.500-1	MK.500-1 M.750-1			
700 - 900 GAM.1400-1	 4	 4	 B:H 4	 B:H 4	 B:H 6			SKG geprüfte Bänder
901 - 1300 GAM.1400-1	 4	 4	 4	 B:H 4	 B:H 6			
1301 - 1400 GAM.1400-1	 5	 5	 5	 5	 7			
1401 - 1800 MK.250-1 GAM.1400-1 MK.250-1	 7	 7	 7	 7	 >2,5m ² 9			
1801 - 1900 MK.250-1 GAM.1400-1 MK.250-1	 7	 7	 7	 >2,5m ² 7	 >2,5m ² 9			
1901 - 2300 MK.500-1 GAM.1400-1 MK.500-1	 7	 7	 >2,5m ² 7	 >2,5m ² 7	 >2,5m ² 9			
	Dornmaß des Getriebes entsprechend Profil- situation auswählen ! (> D15,5)							
	* Verriegelungsabstand 700 mm siehe Rahmenteilpositionen							
	350 - 630 M.250-1	631 - 1025 M.500-1	1026 - 1250 M.750-1	1251 - 1475 MK.500-1 M.500-1	1475 - 1725 MK.500-1 M.750-1			

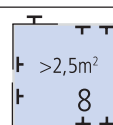

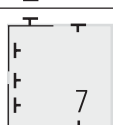
activPilot Concept
Drehfenster
mit SKG geprüften Bändern
außenöffnend, konstanter Griffsitz

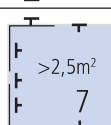
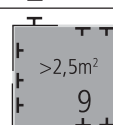
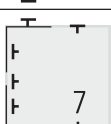
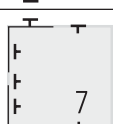
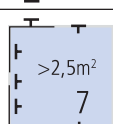
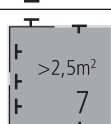
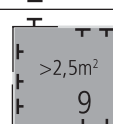
211412

FFB / FFH	350 - 630	631 - 1025	1026 - 1250	1251 - 1475	1476 - 1725			V800*
	M.250-1	M.500-1	M.750-1	MK.500-1 M.500-1	MK.500-1 M.750-1			
975 - 1075 GAK.1325-1								SKG geprüfte Bänder
1076 - 1325 GAK.1325-1								
1326 - 1575 MK.250-1 GAK.1325-1								
1576 - 1775 MK.500-1 GAK.1325-1								
1776 - 1825 GAK.1325-1 MK.500-1								
1826 - 2075 MK.250-1 GAK.1325-1 MK.500-1								
2076 - 2225 MK.500-1 GAK.1325-1 MK.500-1								
	Dornmaß des Getriebes entsprechend Profil- situation auswählen ! (> D15,5)							
					* Verriegelungsabstand 700 mm siehe Rahmenteilpositionen			
	350 - 630 M.250-1	631 - 1025 M.500-1	1026 - 1250 M.750-1	1251 - 1475 MK.500-1 M.500-1	1475 - 1725 MK.500-1 M.750-1			

Rahmenteilpositionen Maßbezüge Drehfenster

Mittiger Griffsitz
GAM...

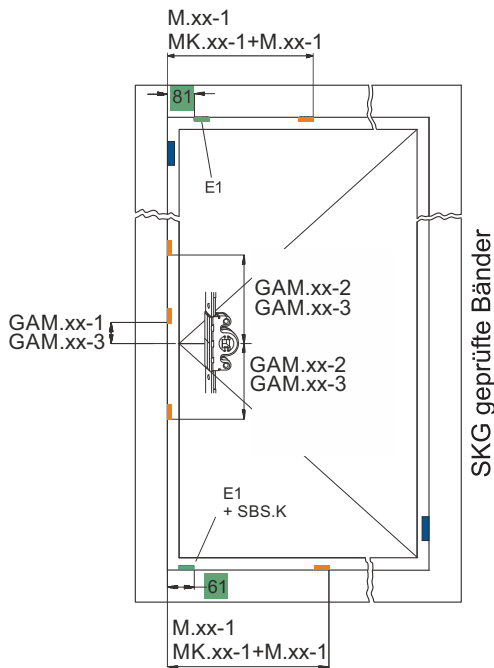

Konstanter Griffsitz
GAK...

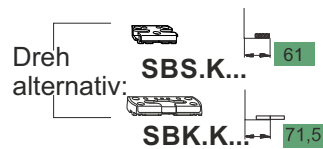
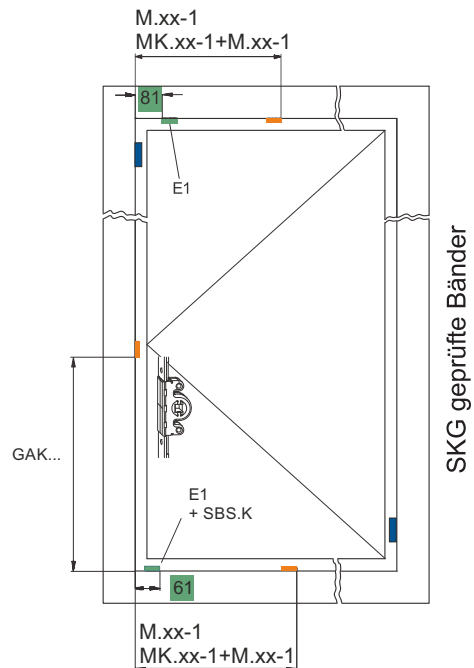

Maßbezug
Sicherheitsschließteil
SBS.K

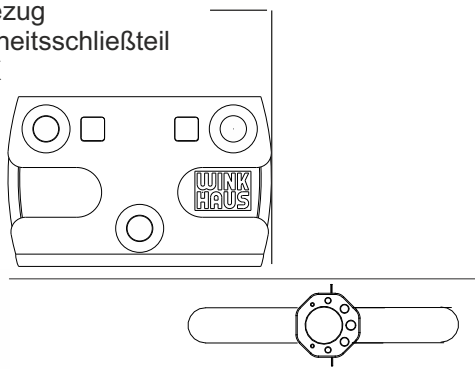

Rahmenteilpositionen Getriebe

Verriegelungsabstand 800 mm

Konstanter Griffsitz 1 flg

FFH min/max	Getriebe		SB Positionen
230 - 460	GA..K.465		--
461 - 700	GA..K.710		--
701 - 850	GA..K.945-1		385
851 - 1100	GA..K.1100-1		500
1101 - 1325	GA..K.1325-1		750
1326 - 1550	GA..K.1550-1	1	750
1550 - 1775	GA..K.1775-2	2	750 1250
1776 - 2000	GA..K.2000-2	2	750 1250
2001 - 2225	GA..K.2225-2	2	750 1500



mittiger Griffsitz 1 flg

FFH min/max	Getriebe		SB Positionen
230 - 325	GA..K.465		--
326 - 800	GA..M 800		--
800 - 1050	GA..M.1050-1		127
1051 - 1300	GA..M.1400-1		127
1301 - 1400	GA..M.1400-1	1	127
1401 - 1800	GA..M.1800-2	2	-340 260
1801 - 2300	GA..M.2300-3	2	-520 127 692



Verriegelungsabstand 700 mm

konstanter Griffsitz

FFH min/max	Getriebe		SB Positionen
230 - 460	GA..K.465		--
461 - 700	GA..K.710		--
701 - 850	GA..K.945-1		385
851 - 1100	GA..K.1100-1		500
1101 - 1325	GA..K.1325-2		385 750
1326 - 1550	GA..K.1550-2	1	385 1000
1551 - 1775	GA..K.1775-3	2	385 750 1250
1776 - 2000	GA..K.2000-4	2	385 750 1250 1500
2001 - 2225	GA..K.2225-4	2	385 750 1250 1750



mittiger Griffsitz

FFH min/max	Getriebe		SB Positionen
230 - 325	GA..K.465		--
326 - 800	GA..M 800		--
800 - 1050	GA..M.1050-1		127
1051 - 1300	GA..M.1400-2		-223 127
1301 - 1400	GA..M.1400-2	1	-223 127
1401 - 1800	GA..M.1800-2	2	-340 260
1801 - 2300	GA..M..2300-3	2	-520 127 692



Rahmenteilpositionen Getriebe mit Verlängerungen

Mittiger Griffsitz

FFH min/max	Getriebe		SB Positionen
-------------	----------	---	---------------

700 - 1300	GA..M.1400-1		127
------------	--------------	--	-----

1301 - 2300	GA..M.1400-1	1	127
-------------	--------------	---	-----

+ Mittenverriegelung			oben	unten
----------------------	--	--	------	-------

1401 - 1900	2x MK.250-1	2	250	230
-------------	-------------	---	-----	-----

1901 - 2300	2x MK.500-1	2	500	470
-------------	-------------	---	-----	-----



konstanter Griffsitz

FFH min/max	Getriebe		SB Positionen
-------------	----------	---	---------------

975 - 1325	GA..K.1325-1		750
------------	--------------	--	-----

1326 - 2225	GA..K.1325-1	1	750
-------------	--------------	---	-----

+Mittinverriegelung			oben	unten
---------------------	--	--	------	-------

1326 - 1575	MK.250-1	1	250	
-------------	----------	---	-----	--

1576 - 1775	MK.500-1	1	500	
-------------	----------	---	-----	--

1776 - 1825	MK.500-1	1		470
-------------	----------	---	--	-----

1826 - 2075	MK.250-1	1	250	
-------------	----------	---	-----	--

	+MK.500-1	1		470
--	-----------	---	--	-----

2075 - 2225	2x MK.250-1	2	500	470
-------------	-------------	---	-----	-----



Rahmenteilpositionen Mittenverriegelungen

Bandseite

SKG geprüfte Bänder

Details zu geeigneten Produkten siehe
www.sterrenwijzer.nl



Unten

Verriegelungsabstand 700mm



FFB min/max	M../MK..		SB Positionen
270 - 630	M.250-1	1	230
631 - 1025	M.500-1	1	480
1026 - 1250	M.750-1	1	730
1251 - 1475	MK.500-1+ M.500-1	1	500 980
1475 - 1725	MK.500-1+ M.750-1	1	500 1230

Oben

Verriegelungsabstand 700mm



FFB min/max	M../MK..		SB Positionen
270 - 630	M.250-1	1	250
631 - 1025	M.500-1	1	500
1026 - 1250	M.750-1	1	750
1251 - 1475	MK.500-1+ M.500-1	1	500 1000
1475 - 1725	MK.500-1+ M.750-1	1	500 1250



activPilot Concept

Kippfenster

Klappfenster

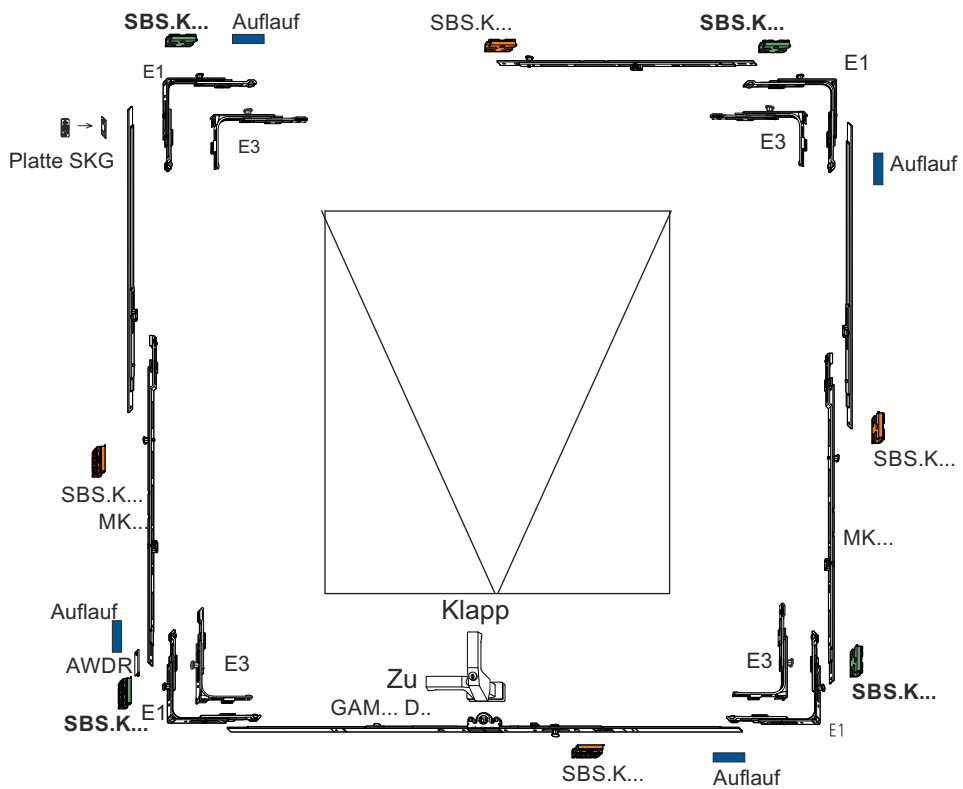
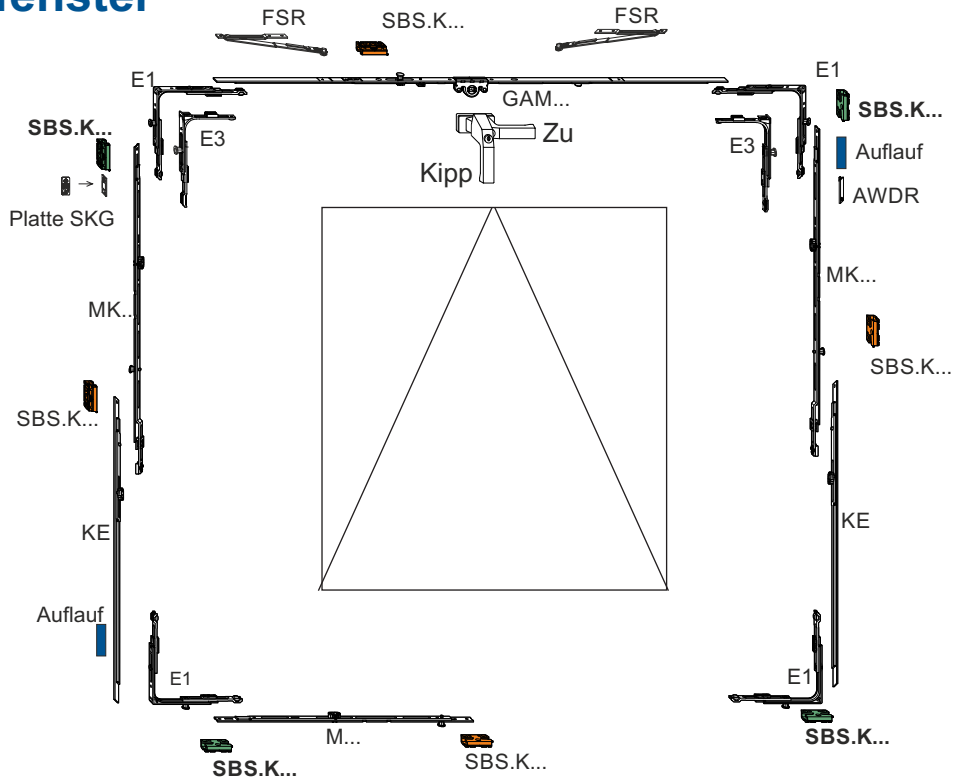

Rahmenteilpositionen Maßbezüge Kipp-/ Klappfenster

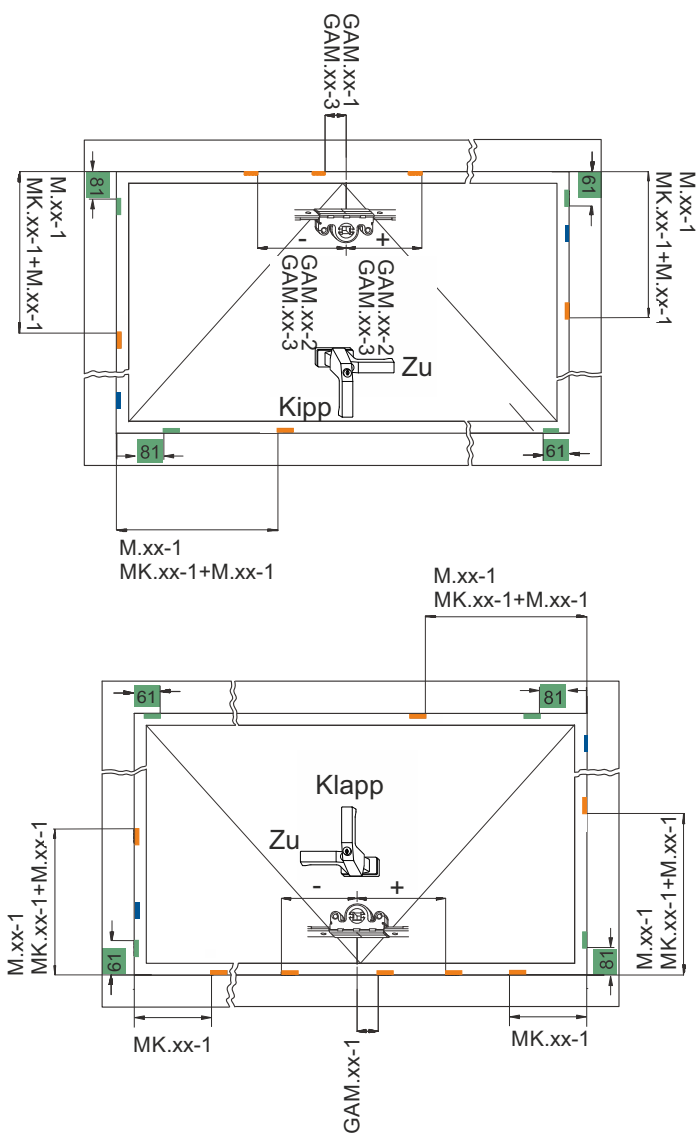

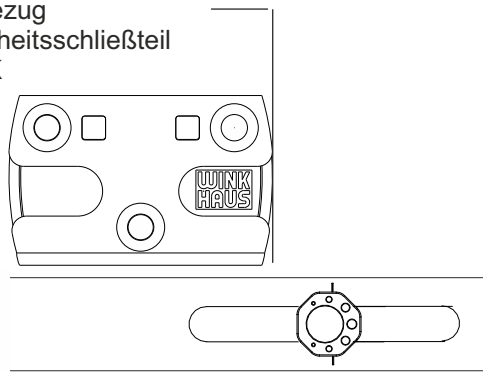

Maßbezug
Sicherheitsschließsteil
SBS.K



Rahmenteilpositionen Getriebe



Verriegelungsabstand 800 mm

mittiger Griffsitz 1 flg

FFB min/max	Getriebe		SB Positionen		
325 - 800	GA..M 800		--		
800 - 1050	GA..M.1050-1		-127		
1051 - 1300	GA..M.1400-1		-127		
1301 - 1400	GA..M.1400-1	1	-127		
1401 - 1800	GA..M.1800-2	2	340	-260	
1801 - 2300	GA..M.2300-3	2	520	-127	-692

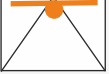

Verriegelungsabstand 700 mm

mittiger Griffsitz

FFB min/max	Getriebe		SB Positionen		
325 - 800	GA..M 800		--		
800 - 1050	GA..M.1050-1		-127		
1051 - 1300	GA..M.1400-2		223	-127	
1301 - 1400	GA..M.1400-2	1	223	-127	
1401 - 1800	GA..M.1800-2	2	340	-260	
1801 - 2300	GA..M..2300-3	2	520	-127	-692

Rahmenteilpositionen Getriebe mit Verlängerungen

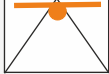
Mittiger Griffsitz

FFB min/max	Getriebe		SB Positionen		
710 - 1300	GA..M.1400-1		-127		
1301 - 2300	GA..M.1400-1	1	-127		
+ Mittsverriegelung			links	rechts	
1401 - 1900	2x MK.250-1	2	250	230	
1901 - 2300	2x MK.500-1	2	500	470	

Rahmenteilpositionen Mittenverriegelungen

seitlich Verriegelungsabstand 700mm

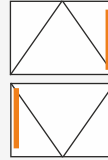

FFH min/max	M../MK..		SB Positionen
360 - 460	KE	-	-
461 - 710	MK.500-1+KE	1	480
711 - 960	MK.750-1+KE	1	730

Seitlich Verriegelungsabstand 700mm

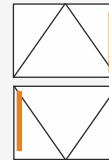

FFH min/max	M../MK..		SB Positionen
360 - 460	KE	-	-
461 - 710	MK.500-1+KE	1	500
711 - 960	MK.750-1+KE	1	750

Mittenverriegelungen Oben / Unten



Verriegelungsabstand 800 mm

konstanter + mittiger Griffsitz

FFH min/max	M../MK..		SB Positionen.
861 - 1285	M.500-1		500
1286 - 1535	M.750-1	1	750
1536 - 1785	MK.500-1 + M.500-1	1	500 1000
1786 - 2035	MK.750-1 + M.500-1	1	750 1250
2036 - 2285	MK.750-1 + MK.750-1	2	750 1500

Verriegelungsabstand 700 mm

konstanter + mittiger Griffsitz

FFH min/max	M../MK..		SB Positionen
760 - 1185	M.500-1		500
1186 - 1435	M.750-1	1	750
1436 - 1685	MK.500-1 + M.500-1	1	500 1000
1686 - 1935	MK.750-1 + M.500-1	1	750 1250
1936 - 2185	MK.500-1 + MK.500-1+ M.500-1	1	500 1000 1500
2185 - 2300	MK.750-1 + MK.500-1+ M.500-1	2	750 1000 1500

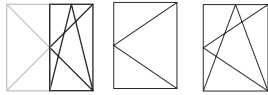

activPilot Select / Topstar Dreh- Drehkipppfenster innen / außenöffnend

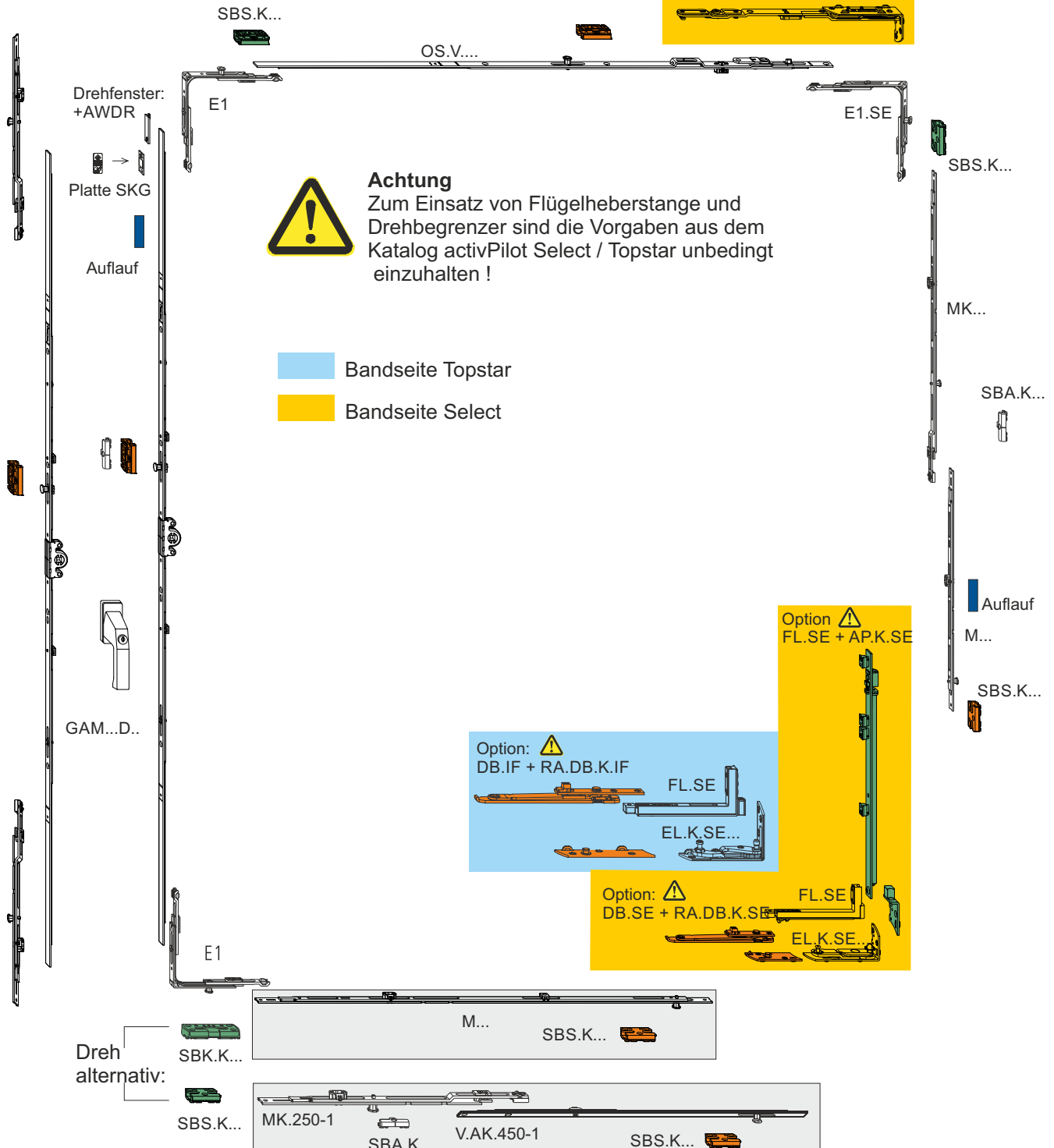
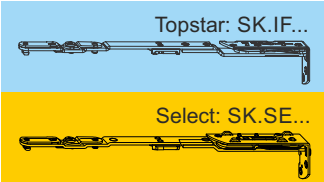



**activPilot Select / Topstar
Drehkippenfenster
innenöffnend, mittiger Griffsitz**

231121

FFB / FFH	485 - 550 OS.SE.550	551 - 800 OS.SE.800	801 - 1025 OS.SE.1025-1	1026 - 1250 OS.SE.1250-1	1251 - 1475 OS.SE.1250-1 +MK.250-1		V800*
325 - 510 GAM.800						<p>Hinweis nur für Select</p>	
510 - 710 GAM.800							
711 - 980 GAM.1050-1							860 - 980 M.500-1
981 - 1300 GAM.1400-1							981 -1285 M.500-1
1301 - 1400 GAM.1400-1							1286- 1535 M.750-1
1401 - 1800 GAM.1800-2							1536 - 1785 MK.500-1 M.500-1
1801 - 2000 GAM.2300-3 (2x SBS)							1786 - 2035 MK.750-1 M.500-1
2001 - 2300 GAM.2300-3 (2x SBS)						2036 - 2300 MK.750-1 M.750-1	
						<p>* Verriegelungsabstand 700 mm siehe Rahmenteilpositionen !</p>	
ohne Drehbegrenzer	485* - 700 M.250-1	701 - 1025 M.500-1	—	1026 - 1250 M.750-1		<p>DB.SE DB.IF</p>	
mit Drehbegrenzer	570 - 815 M.250-1	816 - 1065 M.500-1	—	1066 - 1315 M.750-1	1316 - 1475 MK.500-1 M.500-1	<p>DB.SE DB.IF</p>	
	600 - 850 V.AK.450-1	851 - 1100 MK.250-1 V.AK.450-1	—	1101 - 1350 MK.500-1 V.AK.450-1	1351 - 1475 MK.750-1 V.AK.450-1		



activPilot Select / Topstar
Stulpfenster, erstöffnender Flügel
Drehkipp
innenöffnend, mittiger Griffsitz

231221

FFB / FFH	485* - 550 OS.SE.550 Startmaß unten beachten !	551 - 800 OS.SE.800	801 - 1025 OS.SE.1025-1	1026 - 1250 OS.SE.1250-1	1251 - 1475 OS.SE.1250-1 +MK.250-1		V800*
410 - 560 GAM.800						<p>Hinweis nur für Select</p>	
560 - 710 GAM.800							
711 - 980 GAM.1050-1							860 - 980 M.500-1
981 - 1300 GAM.1400-2							981 - 1285 M.500-1
1301 - 1400 GAM.1400-2							1286 - 1535 M.750-1
1401 - 1800 GAM.1800-2							1536 - 1785 MK.500-1 M.500-1
1801 - 2000 GAM.2300-3							1786 - 2035 MK.750-1 M.500-1
2001 - 2300 GAM.2300-3						2036 - 2300 MK.750-1 M.750-1	
						* Verriegelungsabstand 700 mm siehe Rahmenteilpositionen	
ohne Drehbegrenzer	485* - 700 M.250-1	701 - 1025 M.500-1	—	1026 - 1250 M.750-1			
mit Drehbegrenzer	570 - 815 M.250-1	816 - 1065 M.500-1	—	1066 - 1315 M.750-1	1316 - 1475 MK.500-1 M.500-1	DB.SE DB.IF 	
	600 - 850 V.AK.450-1	851 - 1100 MK.250-1 V.AK.450-1	—	1101 - 1350 MK.500-1 V.AK.450-1			1351 - 1475 MK.750-1 V.AK.450-1



activPilot Select / Topstar
Stulpfenster, zweitöffnender Flügel
Dreh
innenöffnend, mittiger Griffsitz









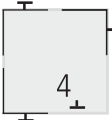
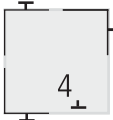
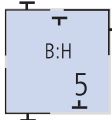
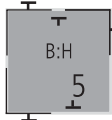
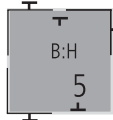

231221

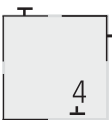
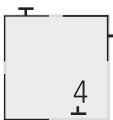
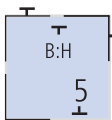
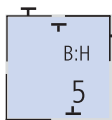
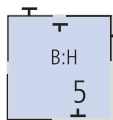
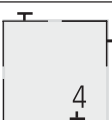
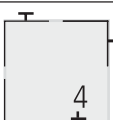
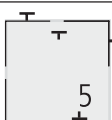
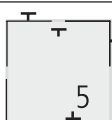
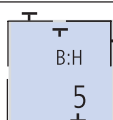
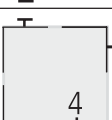
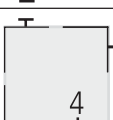
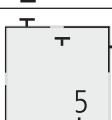
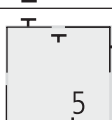
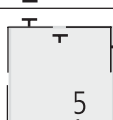
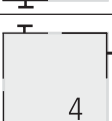
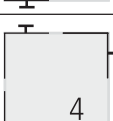
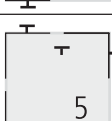
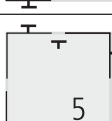
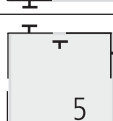
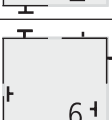
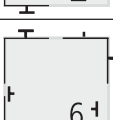
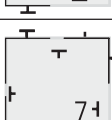
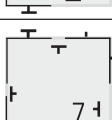
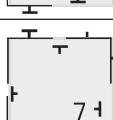
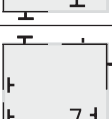
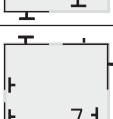
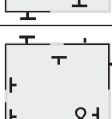
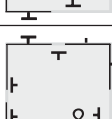
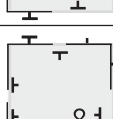
FFB / FFH	485* - 550 OS.SE.550 Startmaß unten beachten !	551 - 800 OS.SE.800	801 - 1025 OS.SE.1025-1	1026 - 1250 OS.SE.1250-1	1251 - 1475 OS.SE.1250-1 +MK.250-1		V800*
410 - 560 GASM.800						<p>Hinweis nur für Select</p> <p>Hinweis nur für Select FFH > 1500</p>	<p>* Verriegelungsabstand 700 mm siehe Rahmenteilpositionen</p> <p>860 - 980 M.500-1</p> <p>981 - 1285 M.500-1</p> <p>1286 - 1535 M.750-1</p> <p>1536 - 1785 MK.500-1 M.500-1</p> <p>1786 - 2035 MK.750-1 M.500-1</p> <p>2036 - 2300 MK.750-1 M.750-1</p>
561 - 710 GASM.800							
711 - 980 GASM.1050-1							
981 - 1300 GASM.1400-2							
1301 - 1400 GASM.1400-2							
1401 - 1800 GASM.1800-2							
1801 - 2000 GASM.2300-3							
2001 - 2300 GASM.2300-3							
						<p>* Verriegelungsabstand 700 mm siehe Rahmenteilpositionen</p>	
ohne Drehbegrenzer	485 - 700 M.250-1	701 - 1025 M.500-1	—	1026 - 1250 M.750-1			
mit Drehbegrenzer	570 - 815 M.250-1	816 - 1065 M.500-1	—	1066 - 1315 M.750-1			
	600 - 850 V.AK.450-1	851 - 1100 MK.250-1 V.AK.450-1	—	1101 - 1350 MK.500-1 V.AK.450-1		1351 - 1475 MK.750-1 V.AK.450-1	

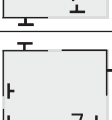
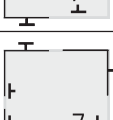
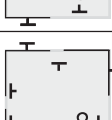
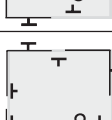

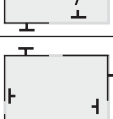
activPilot Select / Topstat
Drehkippenfenster
innenöffnend, konstanter Griffsitz

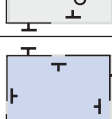
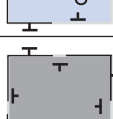
231111

FFB / FFH	485 - 550 OS.SE.550 Startmaß unten beachten !	551 - 800 OS.SE.800	801 - 1025 OS.SE.1025-1	1026 - 1250 OS.SE.1250-1	1251 - 1475 OS.SE.1250-1 +MK.250-1		V800* 
420 - 460 GAK.465						Hinweis nur für Select 	*Verriegelungsabstand 700 mm siehe Rahmenteilpositionen
461 - 700 GAK.710							
701 - 850 GAK.945-1							
851 - 1100 GAK.1100-1							
1101 - 1325 GAK.1325-1							
1326 - 1550 GAK.1550-1							860 - 980 M.500-1
1551 - 1775 GAK.1775-2						Hinweis nur für Select FFH > 1500	981 - 1286 M.500-1
1776 - 2000 GAK.2000-2							1286 - 1535 M.750-1
2001 - 2225 GAK.2225-2							1536 - 1785 MK.500-1 M.500-1
ohne Drehbegrenzer	485 - 700 M.250-1	701 - 1025 M.500-1	—	1026 - 1250 M.750-1			1786 - 2035 MK.750-1 M.500-1
mit Drehbegrenzer	570 - 815 M.250-1	816 - 1065 M.500-1	—	1066 - 1315 M.750-1	1316 - 1475 MK.500-1 M.500-1		
	600 - 850 V.AK.450-1	851 - 1100 MK.250-1 V.AK.450-1	—	1101 - 1350 MK.500-1 V.AK.450-1	1351 - 1475 MK.750-1 V.AK.450-1		



activPilot Select / Topstar
Stulpfenster, erstöffnender Flügel
Drehkipp
innenöffnend, konstanter Griffsitz

231211

FFB FFH	485 - 550	551 - 800	801 - 1025	1026 - 1250	1251 - 1475			V800*
	OS.SE.550 Startmaß unten beachten!	OS.SE.800	OS.SE.1025-1	OS.SE.1250-1	OS.SE.1250-1 +MK.250-1			
450 - 460 GAK.465						Hinweis nur für Select 	* Verriegelungsabstand 700 mm siehe Rahmenteilpositionen	
461 - 700 GAK.710								
701 - 850 GAK.945-1								
851 - 1100 GAK.1100-1								860 - 980 M.500-1
1101 - 1325 GAK.1325-2								981 - 1286 M.500-1
1326 - 1550 GAK.1550-2								1286 - 1535 M.750-1
1551 - 1775 GAK.1775-2						Hinweis nur für Select FFH > 1500	1536 - 1785 MK.500-1 M.500-1	
1776 - 2000 GAK.2000-2							1786 - 2035 MK.750-1 M.500-1	
2001 - 2225 GAK.2225-2							2036 - 2225 MK.750-1 M.750-1	
ohne Dreh- begrenzer	485 - 700 M.250-1	701 - 1025 M.500-1	—	1026 - 1250 M.750-1	—			
mit Dreh- begrenzer	570 - 815 M.250-1	816 - 1065 M.500-1	—	1066 - 1315 M.750-1	1316 - 1475 MK.500-1 M.500-1			
	600 - 850 V.AK.450-1	851 - 1100 MK.250-1 V.AK.450-1	—	1101 - 1350 MK.500-1 V.AK.450-1	1351 - 1475 MK.750-1 V.AK.450-1			

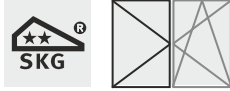

activPilot Select / Topstar
Stulpfenster, zweitöffnender Flügel
Dreh
innenöffnend, konstanter Griffsitz

231211

FFB / FFH	485 - 550	551 - 800	801 - 1025	1026 - 1250	1251 - 1475		V800*
	OS.SE.550 Startmaß unten beachten !	OS.SE.800	OS.SE.1025-1	OS.SE.1250-1	OS.SE.1250-1 +MK.250-1		
450 - 460 GASK.710						Hinweis nur für Select *Verriegelungsabstand 700 mm siehe Rahmenteilpositionen	
461 - 700 GASK.710							
701 - 850 GASK.945-1							
851 - 1100 GASK.1100-1							860 - 980 M.500-1
1101 - 1325 GASK.1325-2							981 - 1286 M.500-1
1326 - 1550 GASK.1550-2							1286 - 1535 M.750-1
1551 - 1775 GASK.1775-2							1536 - 1785 MK.500-1 M.500-1
1776 - 2000 GASK.2000-2							1786 - 2035 MK.750-1 M.500-1
2001 - 2225 GASK.2225-2						2036 - 2225 MK.750-1 M.750-1	
ohne Drehbegrenzer	485 - 700 M.250-1	701 - 1025 M.500-1	—	1026 - 1250 M.750-1		Hinweis nur für Select FFH > 1500 DB.SE DB.IF	
mit Drehbegrenzer	570 - 815 M.250-1	816 - 1065 M.500-1	—	1066 - 1315 M.750-1	1316 - 1475 MK.500-1 M.500-1		DB.SE DB.IF
	600 - 850 V.AK.450-1	851 - 1100 MK.250-1 V.AK.450-1	—	1101 - 1350 MK.500-1 V.AK.450-1	1351 - 1475 MK.750-1 V.AK.450-1		

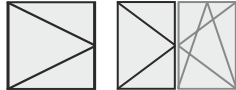

**activPilot Select / Topstar
Dreh
(1 flügelig und Stulp 1.öffnend)
außenöffnend, mittiger Griffsitz**

**231722
231922**

FFB / FFH	485 - 550 OS.SE.550	551 - 800 OS.SE.800	801 - 1025 OS.SE.1025-1	1026 - 1250 OS.SE.1250-1	1251 - 1475 OS.SE.1250-1 +MK.250-1		V800*
700 - 900 GAM.1400-1						<p>Hinweis nur für Select</p> <p>FFH > 1500</p>	860 - 980 M.500-1
901 - 1300 GAM.1400-1							981 -1285 M.500-1
1301- 1400 GAM.1400-1							1286- 1535 M.750-1
1401 - 1800 MK.250-1 GAM.1400-1 MK.250-1							1536 - 1785 MK.500-1 M.500-1
1801 - 1900 MK.250-1 GAM.1400-1 MK.250-1							1786 - 2035 MK.750-1 M.500-1
1901 - 2300 MK.250-1 GAM.1400-1 MK.250-1							2036 - 2300 MK.750-1 M.750-1
	<p>Dornmaß des Getriebes entsprechend Profilsituation auswählen ! (> D15,5)</p>						
						<p>* Verriegelungsabstand 700 mm siehe Rahmenteilpositionen !</p>	
ohne Drehbegrenzer	485 - 700 M.250-1	701 - 1025 M.500-1	—	1026 - 1250 M.750-1			
mit Drehbegrenzer	565 - 810 M.250-1	811 - 1060 M.500-1	—	1061 - 1310 M.750-1	<p>DB.SE DB.IF</p>		
	600 - 850 V.AK.450-1	851 - 1100 MK.250-1 V.AK.450-1	—	1101 - 1350 MK.500-1 V.AK.450-1		1351 - 1475 MK.750-1 V.AK.450-1	

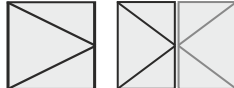

**activPilot Select / Topstar
Dreh
(1 flügelig und Stulp 1.öffnend)
außenöffnend, konstanter Griffsitz**

**231712
231912**

FFB	485 - 550	551 - 800	801 - 1025	1026 - 1250	1251 - 1475			V800*	
FFH	OS.SE.550 Startmaß unten beachten !	OS.SE.800	OS.SE.1025-1	OS.SE.1250-1	OS.SE.1250-1 +MK.250-1				
975 - 1075 GAK.1325-1						<p>Hinweis nur für Select</p>		975 - 1075 M.500-1	
1076 - 1325 GAK.1325-1								1076 - 1285 M.500-1	
1326 - 1575 MK.250-1 GAK.1325-1								1286 - 1535 M.750-1	
1576 - 1775 MK.500-1 GAK.1325-1							FFH > 1500	1536 - 1785 MK.500-1 M.500-1	
1776 - 1825 GAK.1325-1 MK.500-1								1786 - 2035 MK.750-1 M.500-1	
1826 - 2075 MK.250-1 GAK.1325-1 MK.500-1									↓
2076 - 2225 MK.500-1 GAK.1325-1 MK.500-1									2036 - 2225 MK.750-1 M.750-1
	<p>Dornmaß des Getriebes entsprechend Profilsituation auswählen ! (> D15,5)</p>								
								<p>* Verriegelungsabstand 700 mm siehe Rahmenteilpositionen !</p>	
ohne Drehbegrenzer	485* - 700 M.250-1	701 - 1025 M.500-1	→	1026 - 1250 M.750-1					
mit Drehbegrenzer	570 - 815 M.250-1	816 - 1065 M.500-1	→	1066 - 1315 M.750-1	1316 - 1475 MK.500-1 M.500-1				
	600 - 850 V.AK.450-1	851 - 1100 MK.250-1 V.AK.450-1	→	1101 - 1350 MK.500-1 V.AK.450-1	1351 - 1475 MK.750-1 V.AK.450-1				

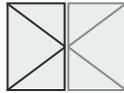

**activPilot Select / Topstar
Dreh
Stulpfenster,zweitöffnender Flügel
außenöffnend, mittiger Griffsitz**

231922

FFB / FFH	485 - 600 OS.SE.550 Startmaß unten beachten !	601 - 800 OS.SE.800	801 - 1025 OS.SE.1025-1	1026 - 1250 OS.SE.1250-1	1251 - 1475 OS.SE.1250-1 +MK.250-1		V800* 	
700 - 900 GASM.1400-1						<p>Hinweis nur für Select</p>	860 - 980 M.500-1	
901 - 1300 GASM.1400-1							981 - 1285 M.500-1	
1301 - 1400 GASM.1400-1							1286 - 1535 M.750-1	
1401 - 1800 MK.250-1 GASM.1400-1 MK.250-1							<p>FFH > 1500</p>	1536 - 1785 MK.500-1 M.500-1
1801 - 2000 MK.SO.250-1 GASM.1400-1 MK.SU.250-1								1786 - 2035 MK.750-1 M.500-1
2001 - 2300 MK.SO.250-1 GASM.1400-1 MK.SU.250-1								2036 - 2300 MK.750-1 M.750-1
						<p>* Verriegelungsabstand 700 mm siehe Rahmenteilpositionen !</p>		
ohne Drehbegrenzer	485* - 700 M.250-1	701 - 1025 M.500-1	—	1026 - 1250 M.750-1				
mit Drehbegrenzer	570 - 815 M.250-1	816 - 1065 M.500-1	—	1066 - 1315 M.750-1	1315 - 1475 MK.500-1 M.500-1	 DB.SE DB.IF		
	600* - 850 V.AK.450-1	851 - 1100 MK.250-1 V.AK.450-1	—	1101 - 1350 MK.500-1 V.AK.450-1	1351 - 1475 MK.750-1 V.AK.450-1			

Rahmenteilpositionen Maßbezüge DK Fenster

Mittiger Griffsitz
GAM...

Konstanter Griffsitz
GAK...

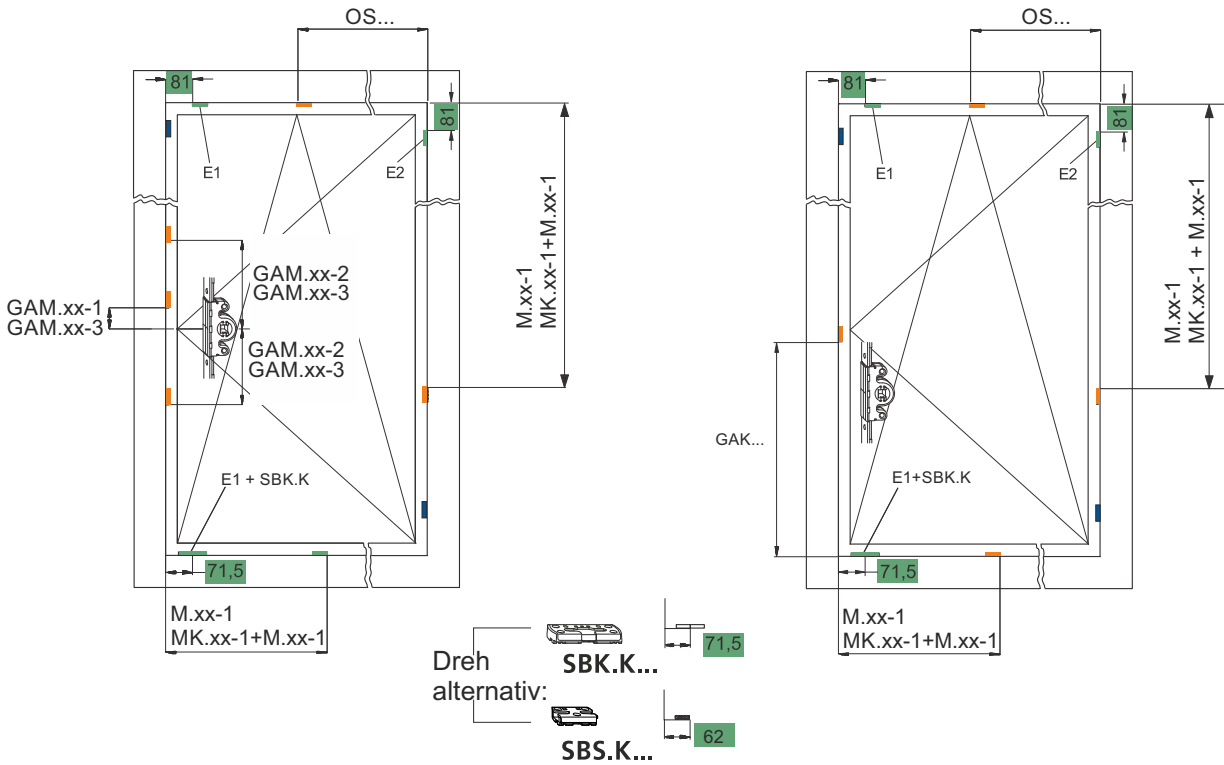

Maßbezug
Sicherheitsschließteil
SBS.K

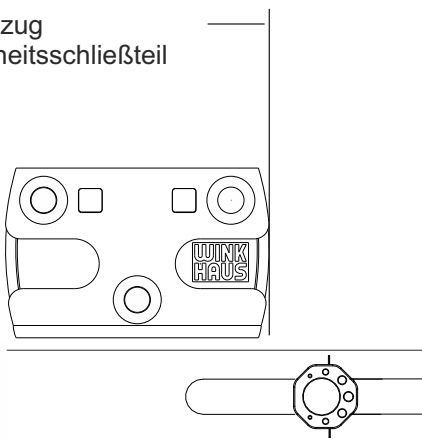

Maßbezug
Sicherheitskippschließblech
SBS.K

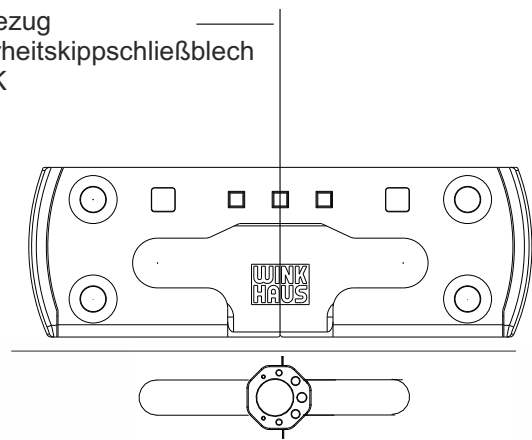

Rahmenteilpositionen Getriebe

Verriegelungsabstand 800 mm

konstanter Griffsitz 1 flg

FFH min/max	Getriebe		SB Positionen
420 - 460	GA..K.465		--
461 - 700	GA..K.710		--
701 - 850	GA..K.945-1		385
851 - 1100	GA..K.1100-1		500
1101 - 1325	GA..K.1325-1		750
1326 - 1550	GA..K.1550-1	1	750
1550 - 1775	GA..K.1775-2	2	750 1250
1776 - 2000	GA..K.2000-2	2	750 1250
2001 - 2225	GA..K.2225-2	2	750 1500



mittiger Griffsitz 1 flg

FFH min/max	Getriebe		SB Positionen
326 - 800	GA..M 800		--
800 - 1050	GA..M.1050-1		127
1051 - 1300	GA..M.1400-1		127
1301 - 1400	GA..M.1400-1	1	127
1401 - 1800	GA..M.1800-2	2	-340 260
1801 - 2300	GA..M.2300-3	2	-520 127 692

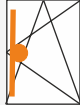

Verriegelungsabstand 700 mm

konstanter Griffsitz

FFH min/max	Getriebe		SB Positionen
420 - 460	GA..K.465		--
461 - 700	GA..K.710		--
701 - 850	GA..K.945-1		385
851 - 1100	GA..K.1100-1		500
1101 - 1325	GA..K.1325-2		385 750
1326 - 1550	GA..K.1550-2	1	385 1000
1551 - 1775	GA..K.1775-3	2	385 750 1250
1776 - 2000	GA..K.2000-4	2	385 750 1250 1500
2001 - 2225	GA..K.2225-4	2	385 750 1250 1750

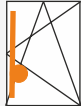

mittiger Griffsitz

FFH min/max	Getriebe		SB Positionen
325 - 800	GA..M 800		--
800 - 1050	GA..M.1050-1		127
1051 - 1300	GA..M.1400-2		-223 127
1301 - 1400	GA..M.1400-2	1	-223 127
1401 - 1800	GA..M.1800-2	2	-340 260
1801 - 2300	GA..M..2300-3	2	-520 127 692

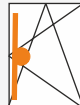

Rahmenteilpositionen Mittenverriegelungen Oberschiene

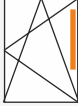

Bandseite Verriegelungsabstand 800 mm

konstanter + mittiger Griffsitz

FFH min/max	M../MK..		SB Positionen.	
860 - 1285	M.500-1		500	
1286 - 1535	M.750-1	1	750	
1536 - 1785	MK.500-1 + M.500-1	1	500	1000
1786 - 2035	MK.750-1 + M.500-1	1	750	1250
2036 - 2300	MK.750-1 + MK.750-1	2	750	1500



Bandseite Verriegelungsabstand 700 mm

konstanter + mittiger Griffsitz

FFH min/max	M../MK..		SB Positionen	
760 - 1185	M.500-1		500	
1186 - 1435	M.750-1	1	750	
1436 - 1685	MK.500-1 + *M.500-1	1	500	*1000
1686 - 1935	MK.750-1 + *M.500-1	1	750	*1250
1936 - 2185	MK.500-1 + MK.500-1+ *M.500-1	1	500	1000 *1500
2185 - 2300	MK.750-1 + MK.500-1+ *M.500-1	2	750	1000 *1500

* Bei Einsatz Flügellagerschiene kann der Einsatz eine ablängbaren Mittenverriegelung V.AK.450-1 erforderlich sein. Der Verschlusspunkt ist in oberhalb der Flügellagerschiene zu setzen.

unten Verriegelungsabstand 700 + 800 mm

FFB min/max	M../MK..		SB Positionen.	
siehe Beschlagmatrix	M.250-1	1	230	
	M.500-1	1	480	
	M.750-1	1	730	
	MK.500-1 + M.500-1	1	480	980
	MK.750-1 + M.500-1	1	730	1230

Oberschiene Verriegelungsabstand 700 + 800 mm

FFB min/max	OS.SE..		SB Positionen.	
270 - 550	OS.SE.550	-	-	
551 - 800	OS.SE.800	-	-	
801 - 1025	OS2.SE.1025-1	1	480	
1026 - 1250	OS2.SE.1250-1	1	480	
1251 - 1475	MK.250-1+OS2.SE.1250-1	1	250	480



duoPort SK 100 S / SK 160 S

Grundgarnitur SK 100 S / SK 160 S
 Details siehe Katalog duoPort SK !

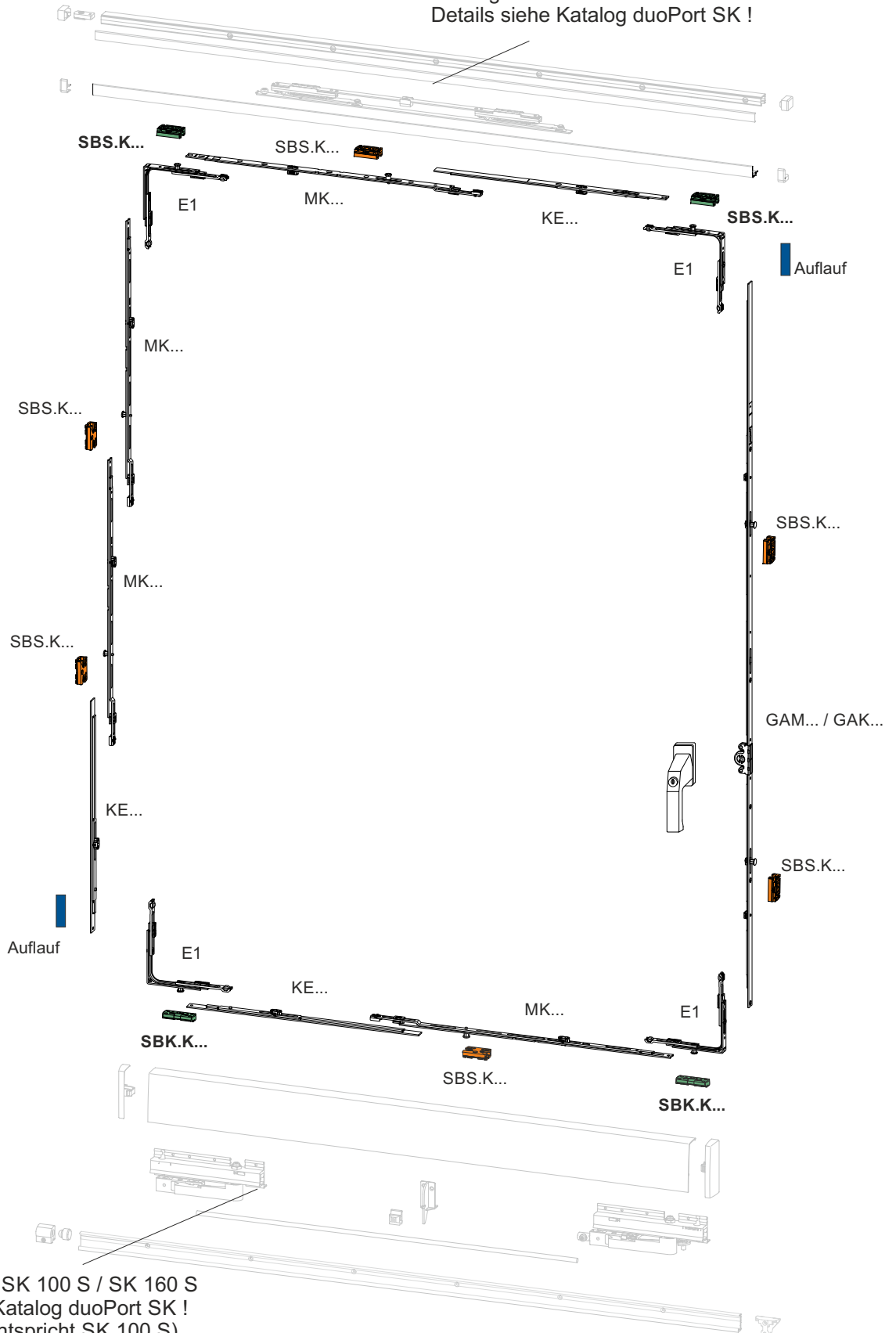

Grundgarnitur SK 100 S / SK 160 S
 Details siehe Katalog duoPort SK !
 (Darstellung entspricht SK 100 S)

Rahmenteilpositionen Maßbezüge DuoPort SK 100 S / SK 160 S

Mittiger Griffsitz
GAM...

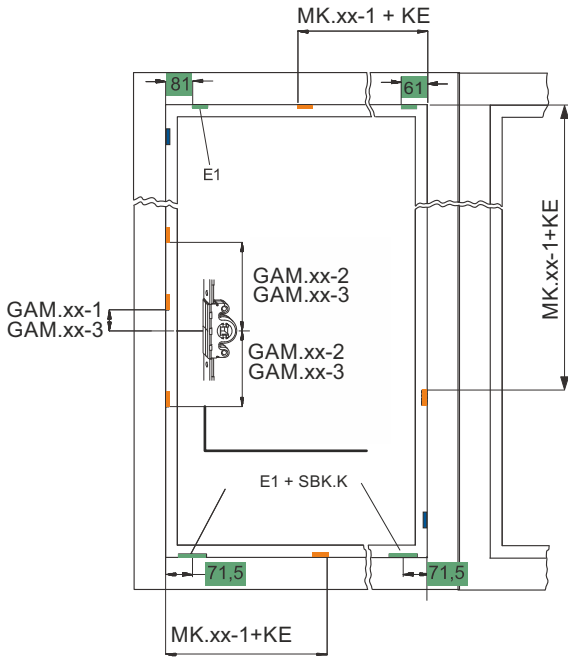

Konstanter Griffsitz
GAK...

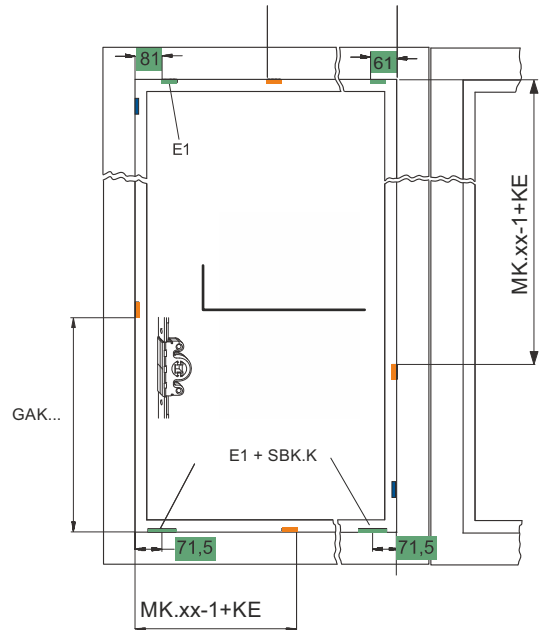

Maßbezug
Sicherheitsschließteil
SBS.K

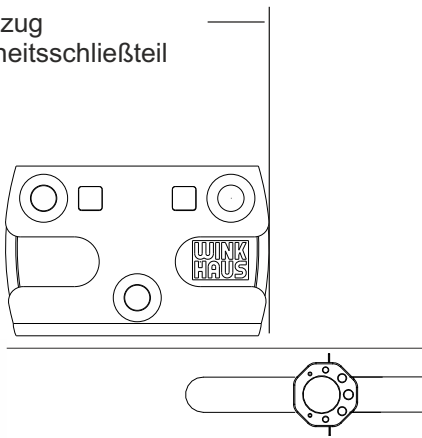

Maßbezug
Sicherheitskippschließblech
SBS.K

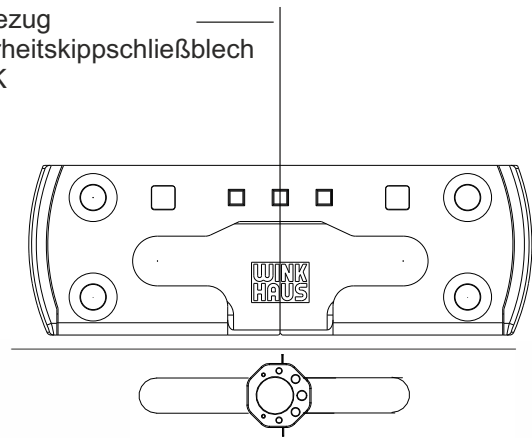

Rahmenteilpositionen Getriebe

Verriegelungsabstand 800 mm

konstanter Griffsitz 1 flg

FFH min/max	Getriebe		SB Positionen
420 - 460	GA..K.465		--
461 - 700	GA..K.710		--
701 - 850	GA..K.945-1		385
851 - 1100	GA..K.1100-1		500
1101 - 1325	GA..K.1325-1		750
1326 - 1550	GA..K.1550-1	1	750
1550 - 1775	GA..K.1775-2	2	750 1250
1776 - 2000	GA..K.2000-2	2	750 1250
2001 - 2225	GA..K.2225-2	2	750 1500



mittiger Griffsitz 1 flg

FFH min/max	Getriebe		SB Positionen
326 - 800	GA..M 800		--
800 - 1050	GA..M.1050-1		127
1051 - 1300	GA..M.1400-1		127
1301 - 1400	GA..M.1400-1	1	127
1401 - 1800	GA..M.1800-2	2	-340 260
1801 - 2300	GA..M.2300-3	2	-520 127 692



Verriegelungsabstand 700 mm

konstanter Griffsitz

FFH min/max	Getriebe		SB Positionen
420 - 460	GA..K.465		--
461 - 700	GA..K.710		--
701 - 850	GA..K.945-1		385
851 - 1100	GA..K.1100-1		500
1101 - 1325	GA..K.1325-2		385 750
1326 - 1550	GA..K.1550-2	1	385 1000
1551 - 1775	GA..K.1775-3	2	385 750 1250
1776 - 2000	GA..K.2000-4	2	385 750 1250 1500
2001 - 2225	GA..K.2225-4	2	385 750 1250 1750



mittiger Griffsitz

FFH min/max	Getriebe		SB Positionen
325 - 800	GA..M 800		--
800 - 1050	GA..M.1050-1		127
1051 - 1300	GA..M.1400-2		-223 127
1301 - 1400	GA..M.1400-2	1	-223 127
1401 - 1800	GA..M.1800-2	2	-340 260
1801 - 2300	GA..M..2300-3	2	-520 127 692



Rahmenteilpositionen Mittenverriegelungen

oben / unten



FFB min/max	M../MK..		SB Positionen
710 - 960	MK.250-1 + KE	1	230
461 - 710	MK.500-1 + KE	1	480
711 - 960	MK.750-1 + KE	1	730

Seitlich



FFH min/max	M../MK..		SB Positionen
650 - 710	KE	-	-
711 - 960	MK.250-1+KE	1	250
961 - 1210	MK.500-1+KE	1	500 (SBS ab FFH 1076)
1211 - 1460	MK.750-1+KE	1	750
1461 - 1710	2x MK.500-1+KE	1	500 1000
1711 - 1960	MK.500-1+MK.750-1+KE	2	500 1250
1961 - 2210	MK.750-1+MK.750-1+KE	2	750 1500
2211 - 2225	2xMK.500-1+MK.750-1+KE	2	500 1000 1750



activPilot Comfort ERGO Drehkipppfenster mit Zwangssteuerung



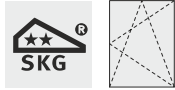

activPilot Ergo
Drehkippfenster mit Zwangssteuerung,
innenöffnend,
konstanter / mittiger Griffsitz

441621

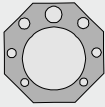
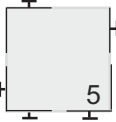
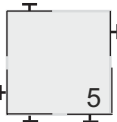
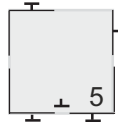
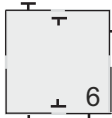
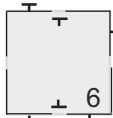
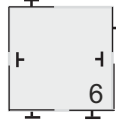
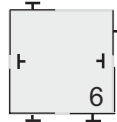
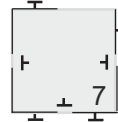
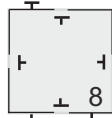
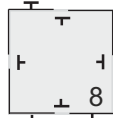
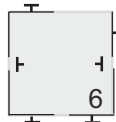
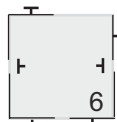
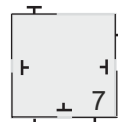
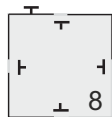
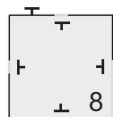
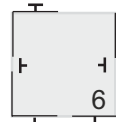
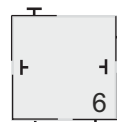
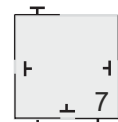
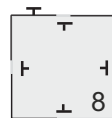
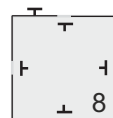
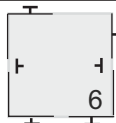
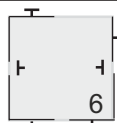
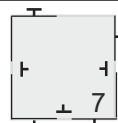
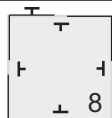
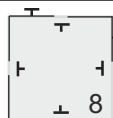
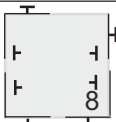
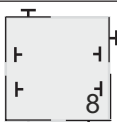
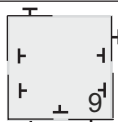
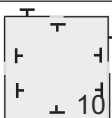
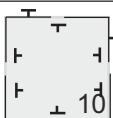
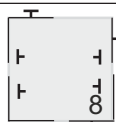
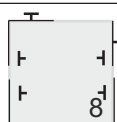
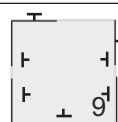
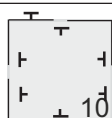
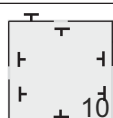
FFB FFH	460 - 615	616 - 865		866 - 1115	1116 - 1200			
	OS.1.EG.615	OS.2.EG.865		OS.2.EG.865 MK.250-1	OS.2.EG.865 MK.500-1			
460 - 710 KE								460 - 710 KE
711 - 960 MK.250-1 KE								711 - 960 MK.250-1 KE
961 - 1210 MK.500-1 KE								961 - 1210 MK.500-1 KE
1211 - 1460 MK.750-1 KE								1211 - 1460 MK.750-1 KE
1461 - 1710 2x MK.500-1 KE								1461 - 1710 2x MK.500-1 KE
1711 - 1960 MK.750-1 MK.500-1 KE								1711 - 1960 MK.750-1 MK.500-1 KE
1961 - 2210 MK.750-1 MK.750-1 KE								1961 - 2210 MK.750-1 MK.750-1 KE
Griffsitz konstant	460 - 580 GAK.710	581 - 695 GAK.830	696 - 945 GAK.945-1	946 - 1100 GAK.1100-1	1101 - 1200 GAK.1325-1			
Griffsitz mittig	511 - 710 GAM.800		711 - 1050 GAM.1050-1		1051 - 1200 GAM.1400-1			

Rahmenteilpositionen Maßbezüge activPilot Comfort

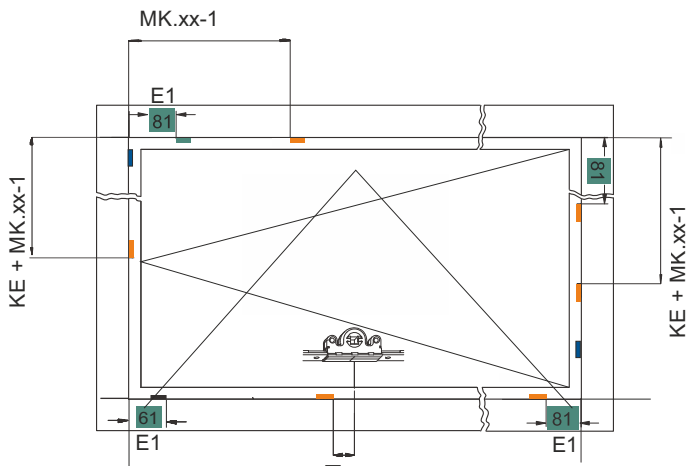
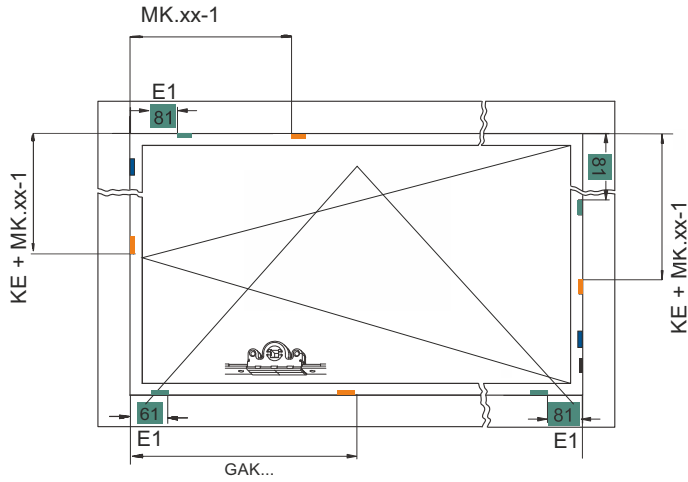

Maßbezug
Sicherheitsschließteil
SBS.K

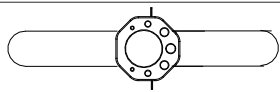
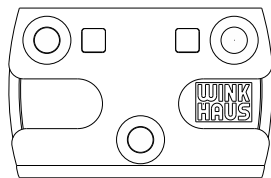

Rahmenteilpositionen

Getriebe Verriegelungsabstand 800 mm

konstanter Griff Sitz

FFB min/max	Getriebe		SB Positionen
460 - 700	GA..K.710		--
701 - 850	GA..K.945-1	1	385
851 - 1100	GA..K.1100-1	1	500
1101 - 1200	GA..K.1325-1	1	750

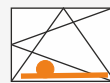

mittiger Griff Sitz

FFB min/max	Getriebe		SB Positionen
460 - 800	GA..M.800		--
800 - 1050	GA..M.1050-1	1	127
1051 - 1300	GA..M.1400-1	1	127
1301 - 1200	GA..M.1400-1	1	127

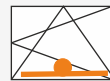

Getriebe Verriegelungsabstand 700 mm

konstanter Griff Sitz

FFB min/max	Getriebe		SB Positionen
460 - 700	GA..K.710		--
701 - 850	GA..K.945-1		385
851 - 1100	GA..K.1100-1		500
1101 - 1325	GA..K.1325-2	1	385 750



mittiger Griff Sitz

FFB min/max	Getriebe		SB Positionen
460 - 800	GA..M.800		--
800 - 1050	GA..M.1050-1		127
1051 - 1200	GA..M.1400-2	1	-223 127

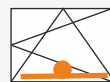

Oberschiene

FFB min/max	Getriebe		SB Positionen
460 - 1200	OSx.EG.xxx	-	-
866 - 1115	+MK.250-1	1	250
1115 - 1200	+MK.500-1	1	500

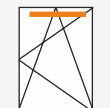

Seitlich

FFB min/max	Mitten verriegelung		SB Positionen Band-	Öffnungsseite
711 - 960	MK.250-1	2	250	230
961 - 1210	MK.500-1	2	500	470
1211 - 1460	MK.750-1	2	750	720
1211 - 1460	2x MK.500-1	2	1000	970
1461 - 1710	MK.750-1	2	750	720
	+ MK.500	+2	1250	1220
1711 - 2210	MK.750-1	2	750	720
	+ MK.750	+2	1250	1220

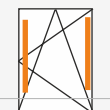

Aug. Winkhaus GmbH & Co. KG

August-Winkhaus-Straße 31
D-48291 Telgte
T +49 (0) 25 04-921-0
F +49 (0) 25 04-921-340

www.winkhaus.de
fenstertechnik@winkhaus.de